

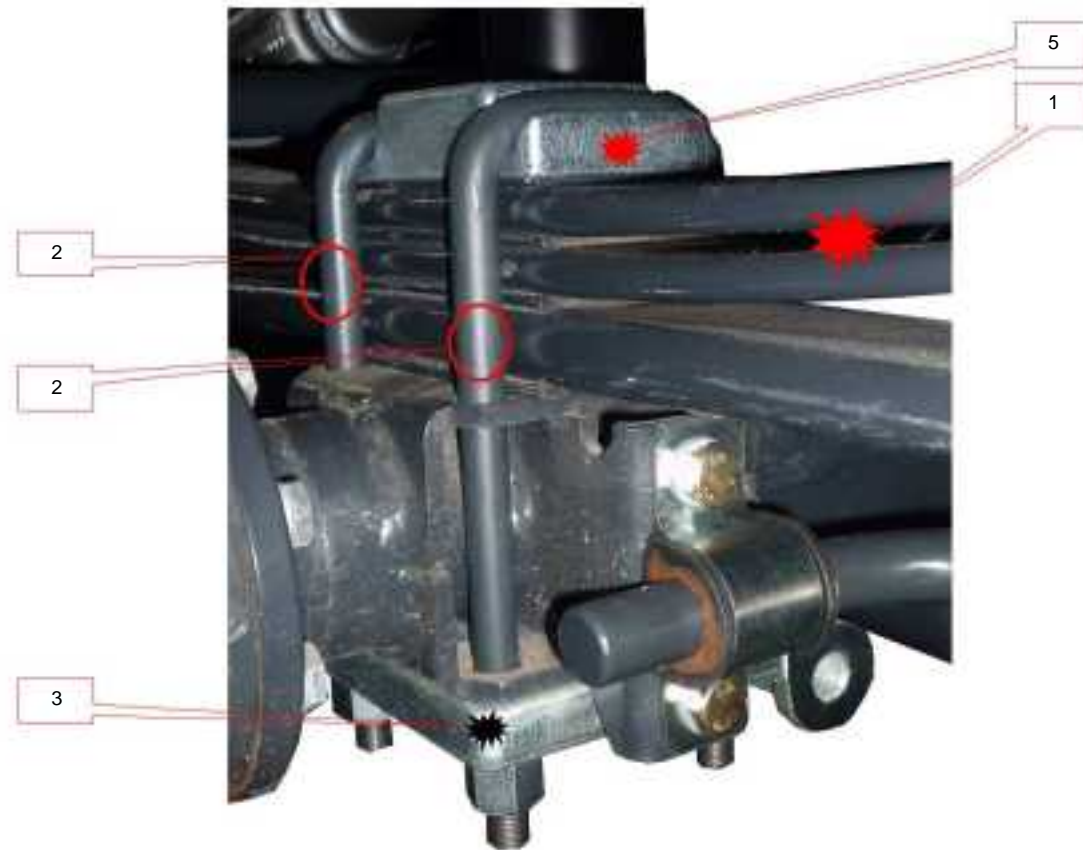

Catalogo Ricambi 2012

BREMACH

BREMACH



SOSPENSIONE ANTERIORE

Pos	Codice	Descrizione	Q.tà
1	96B9102	ASSIEME BALESTRA PARAB.	2
1	96B9106	ASSIEME BALESTRA PARAB. 35/60 Q.LI SAHARA	2
2	91B1021	U BOLT (CAVALLOTTO M14X71 L=210)	4
3	95A1002	PLATE (PIASTRA AMMORTIZZATORE)	2
5	95A1001	PLATE (PIASTRA TAMPONE)	2

SOSPENSIONE ANTERIORE

BREMACH

BREMACH

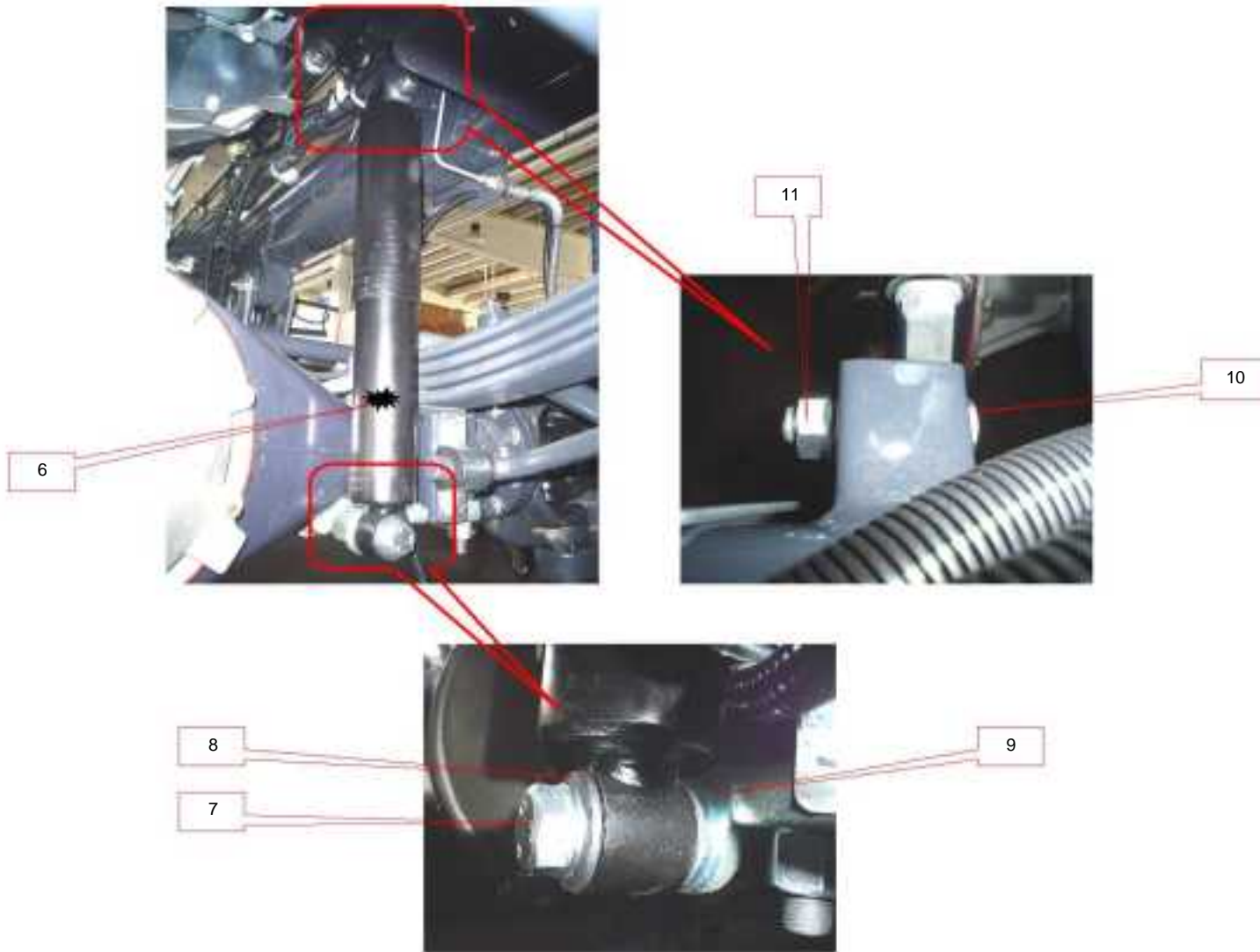

SOSPENSIONE ANTERIORE

Pos	Codice	Descrizione	Q.tà
6	91B1007	SHOCK ABSORBER (AMMORTIZZATORE ANTERIORE 50-60 Q.LI)	2
6	92B1006	SHOCK ABSORBER (AMMORTIZZATORE ANTERIORE 35 Q.LI)	2
7	201060	SCREW (VITE M16X65 UNI 5737-65 ZINCOT)	2
8	90A1007	WASHER (RONDELLA PER AMMORTIZZATORE)	2
9	203109	WASHER (RONDELLA PIANA 16X28X2,5 UNI 1750)	2
10	201060	SCREW (VITE M16X65 UNI 5737-65 ZINCOT)	2
11	16750621	NUT (DADO EF AUTOBL. M16)	2

SOSPENSIONE ANTERIORE

BREMACH

BREMACH

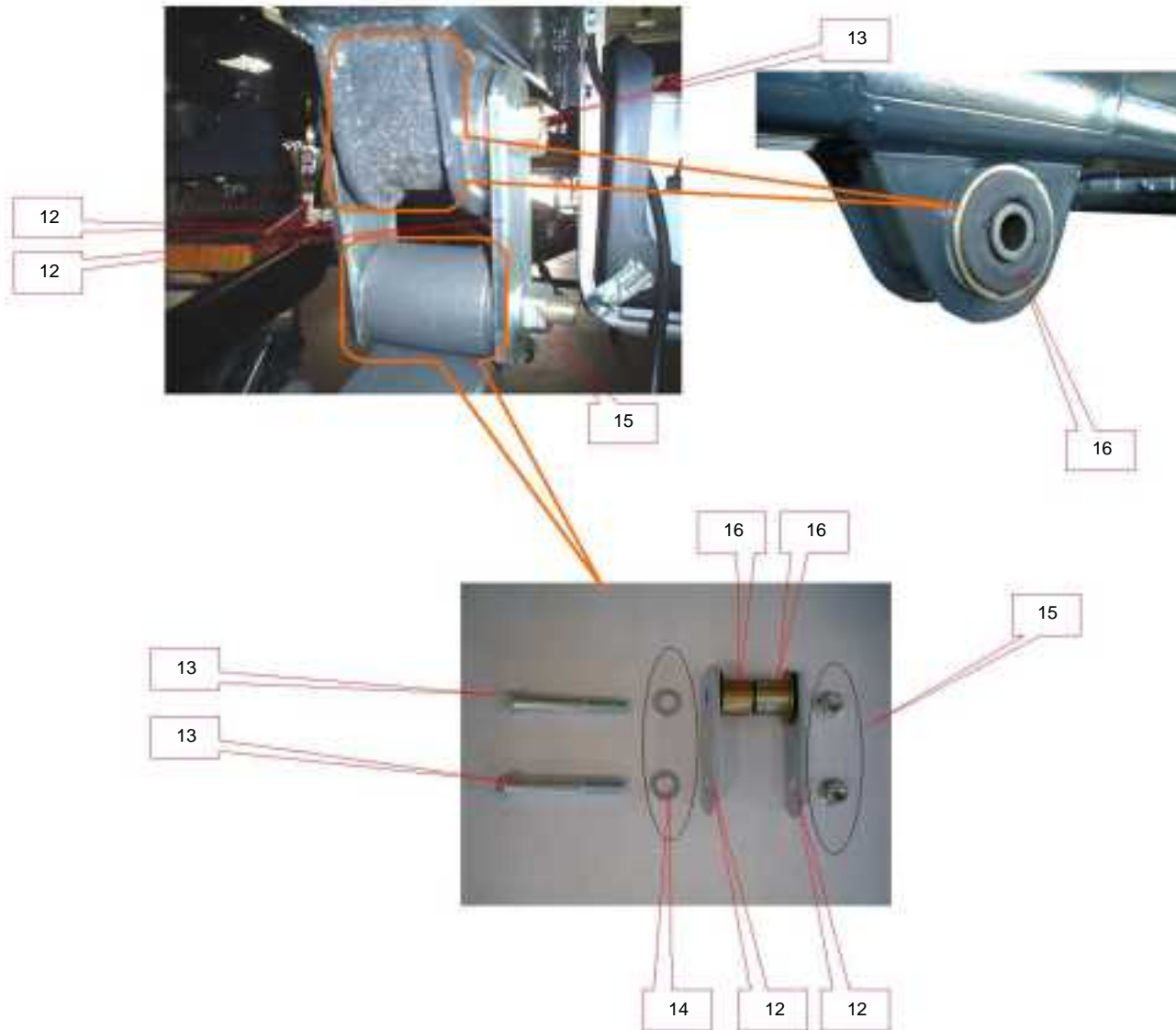

SOSPENSIONE ANTERIORE

BREMACH

Pos	Codice	Descrizione	Q.tà
12	2525009	LINK (BISCOTTINO ZINCATO)	4
13	201180	SCREW (VITE M16X20 R10 UNI 5737)	4
14	203009	WASHER (RONDELLA D.16 A DX)	4
15	16750621	NUT (DADO EF AUTOBL. M16)	4
16	91B1009	SILENTBLOCK (SILENTBLOCK BISCOTT. BALESTRA)	4

SOSPENSIONE ANTERIORE

BREMACH

BREMACH

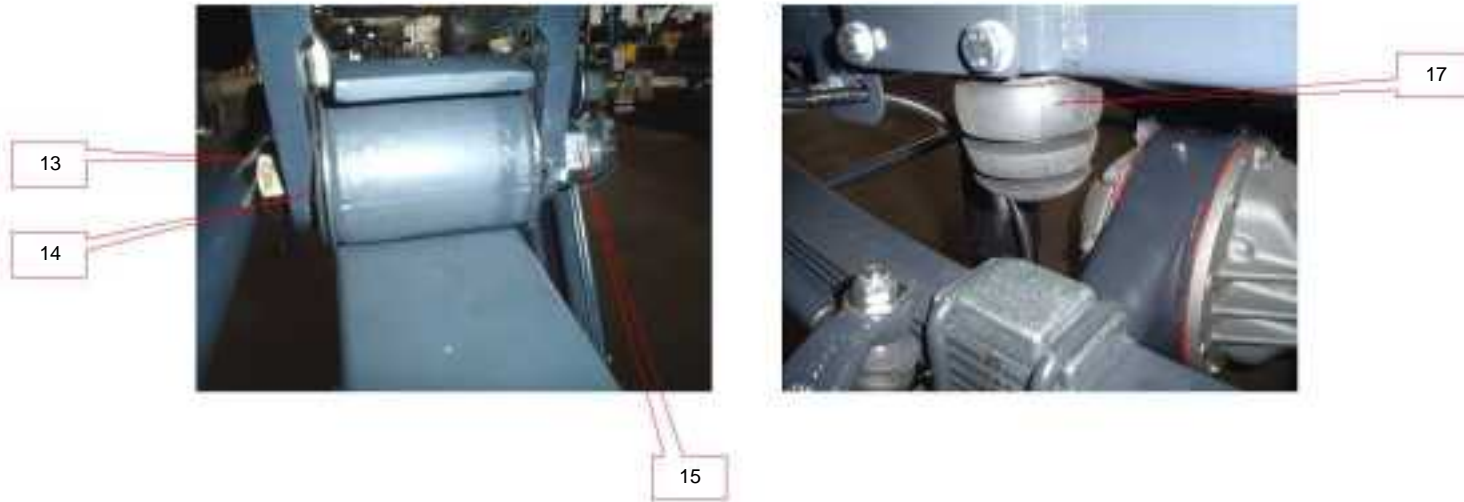

SOSPENSIONE ANTERIORE

BREMACH

Pos	Codice	Descrizione	Q.tà
13	201196	SCREW (VITE M16X130 R10 ZNG UNI 5737)	2
14	203009	WASHER (RONDELLA D.16 A DX)	1
15	1675061	NUT (DADO EF M16)	2
17	95A1003	BUFFER (TAMPONE FINE CORSA)	2

SOSPENSIONE ANTERIORE

BREMACH

BREMACH

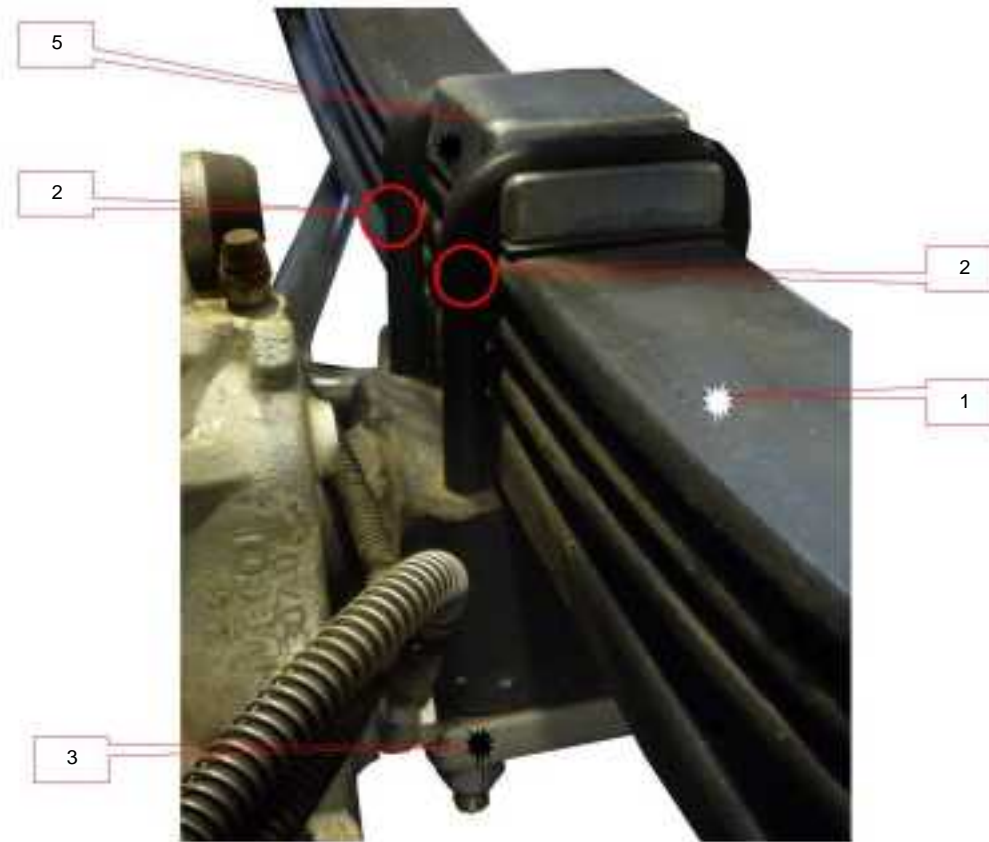

SOSPENSIONE POSTERIORE

Pos	Codice	Descrizione	Q.tà
1	96A9102	WHOLE (ASSIEME BALESTRA PARAB. 60 Q.LI e 35 Q.LI)	2
1	96A9105	WHOLE (ASSIEME BALESTRA PARAB. 60 Q.LI VERSIONE SAHARA)	2
1	96B9106	ASSIEME BALESTRA PARAB. 35/60 Q.LI SAHARA	2
2	91A1004	U BOLT (CAVALLOTTO POSTERIORE 4X4 (5 - 6 T))	4
3	95A1002	PLATE (PIASTRA AMMORTIZZATORE)	2
5	95A1001	PLATE (PIASTRA TAMPONE)	2

SOSPENSIONE POSTERIORE

BREMACH

BREMACH

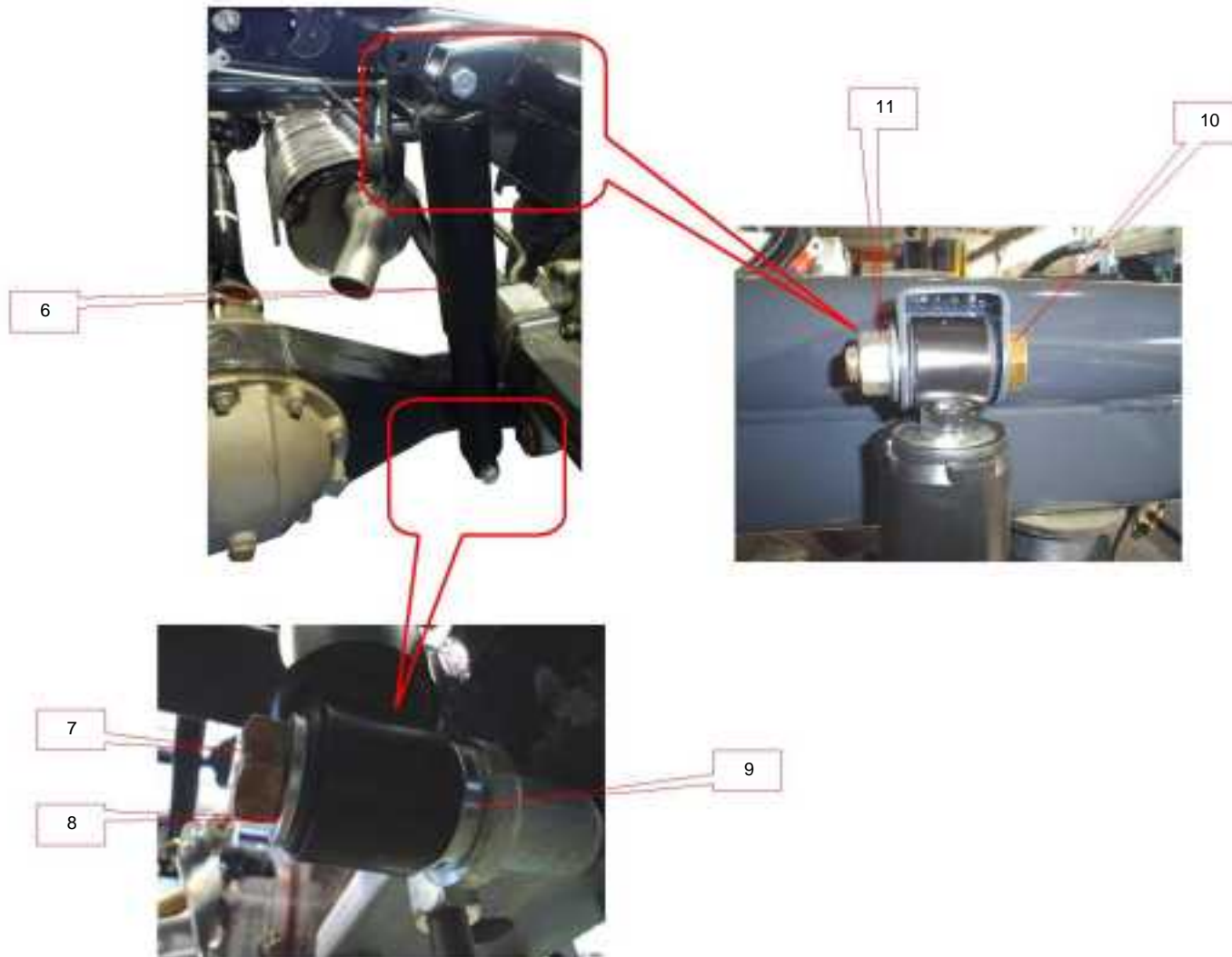

SOSPENSIONE POSTERIORE

Pos	Codice	Descrizione	Q.tà
6	91A1003	SHOCK ABSORBER (AMMORTIZZATORE POSTERIORE 4X4 (60 e 35 Q.LI))	2
7	201060	SCREW (VITE M16X65 UNI 5737-65 ZINCOT)	2
8	203109	WASHER (RONDELLA PIANA 16X28X2,5 UNI 1750)	2
9	90A1007	WASHER (RONDELLA PER AMMORTIZZATORE)	2
10	201060	SCREW (VITE M16X65 UNI 5737-65 ZINCOT)	2
11	16750621	NUT (DADO EF AUTOBL. M16)	2

SOSPENSIONE POSTERIORE

BREMACH

BREMACH

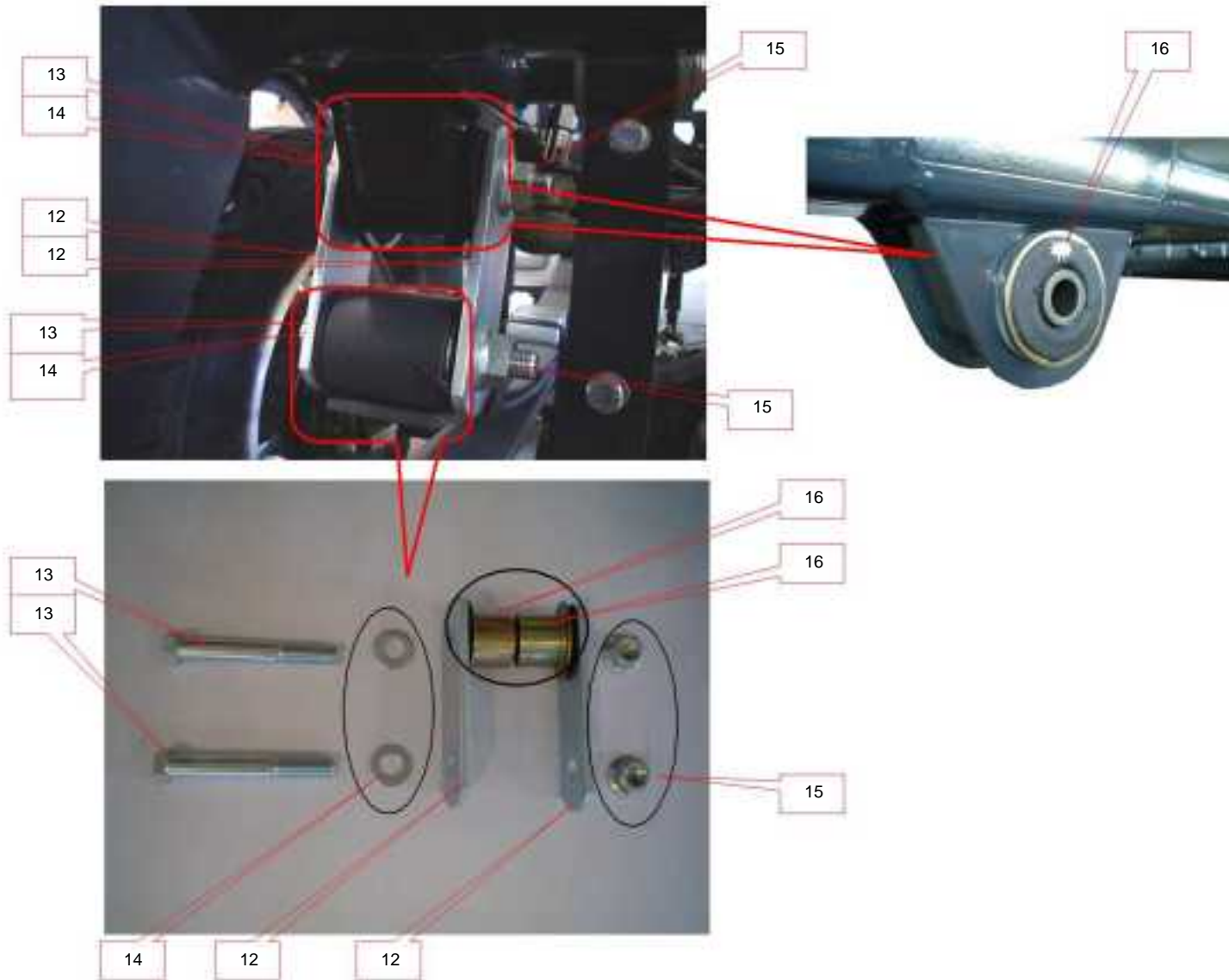

SOSPENSIONE POSTERIORE

BREMACH

Pos	Codice	Descrizione	Q.tà
12	2525009	LINK (BISCOTTINO ZINCATO)	4
13	201180	SCREW (VITE M16X20 R10 UNI 5737)	6
14	203109	WASHER (RONDELLA PIANA 16X28X2,5 UNI 1750)	6
15	16750621	NUT (DADO EF AUTOBL. M16)	6
16	91B1009	SILENTBLOCK (SILENTBLOCK BISCOTT. BALESTRA)	4

SOSPENSIONE POSTERIORE

BREMACH

BREMACH



SOSPENSIONE POSTERIORE

Pos	Codice	Descrizione	Q.tà
13	201180	SCREW (VITE M16X20 R10 UNI 5737)	6
14	203109	WASHER (RONDELLA PIANA 16X28X2,5 UNI 1750)	2
15	16750221	NUT (DADO EF M8)	4
17	91A1007	BUFFER (TAMPONE FINE CORSA)	2
19	16750621	NUT (DADO EF AUTOBL. M16)	2
20	201042	SCREW (VITE M10X30)	2
21	202103	NUT (DADO AUTOBLOCC M10)	2
22	203004	WASHER (RONDELLA D.10)	2

SOSPENSIONE POSTERIORE

BREMACH

BREMACH

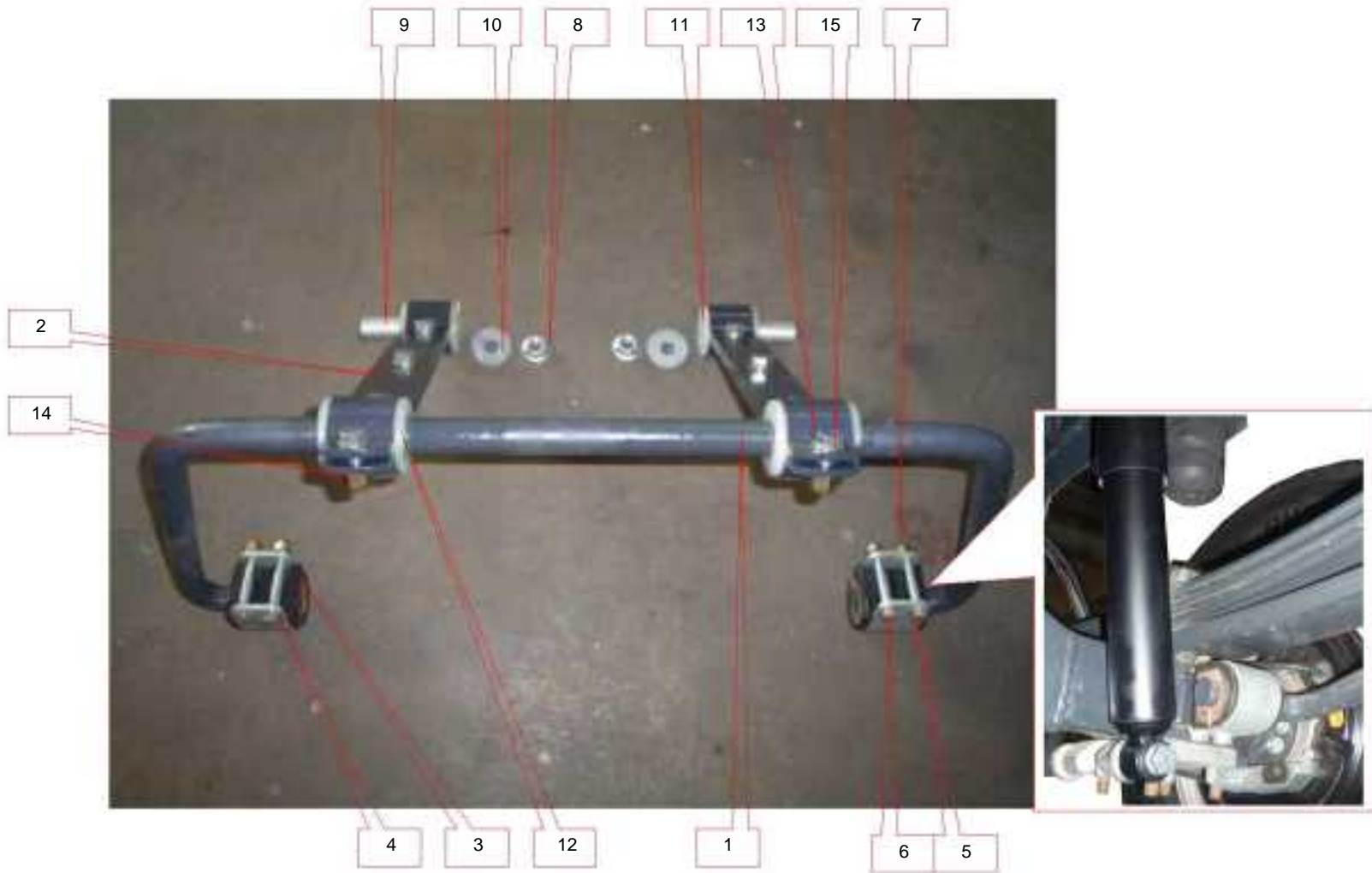

BARRA POSTERIORE

Pos	Codice	Descrizione	Q.tà
1	91B1026	BAR (BARRA DI TORS. D. 28mm SOSP. EST.)	1
2	91B1022	ROD (BIELLA BARRA DI TORS.)	4
3	91B1015	DOWEL (TASSELLO DI GOMMA)	2
4	91B1016	U BOLT (CAVALLOTTO BARRA TORSIONE)	2
5	203004	WASHER (RONDELLA D.10)	4
6	201078	SCREW (VITE M10X80 UNI 5737-65 ZINC.)	4
7	202103	NUT (DADO AUTOBLOCC M10)	4
8	16750621	NUT (DADO EF AUTOBL. M16)	2
9	91B1014	BUSH (BOCCOLA DISTANZIALE)	2
10	203125	WASHER (RONDELLA PIANA 18X48X4 UNI 6593 CAT. C)	2
11	91B1013	BUSH (BOCCOLA DI GOMMA)	2
12	91B1012	BUSH (BOCCOLA PER BARRA D. 28)	2
13	201075	SCREW (VITE M12 X 35)	10
14	202104	NUT (DADO AUTOBLOCCANTE M12)	10
15	203005	COLLAR (ROSETTA D. 12)	10

BARRA POSTERIORE

BREMACH

BREMACH

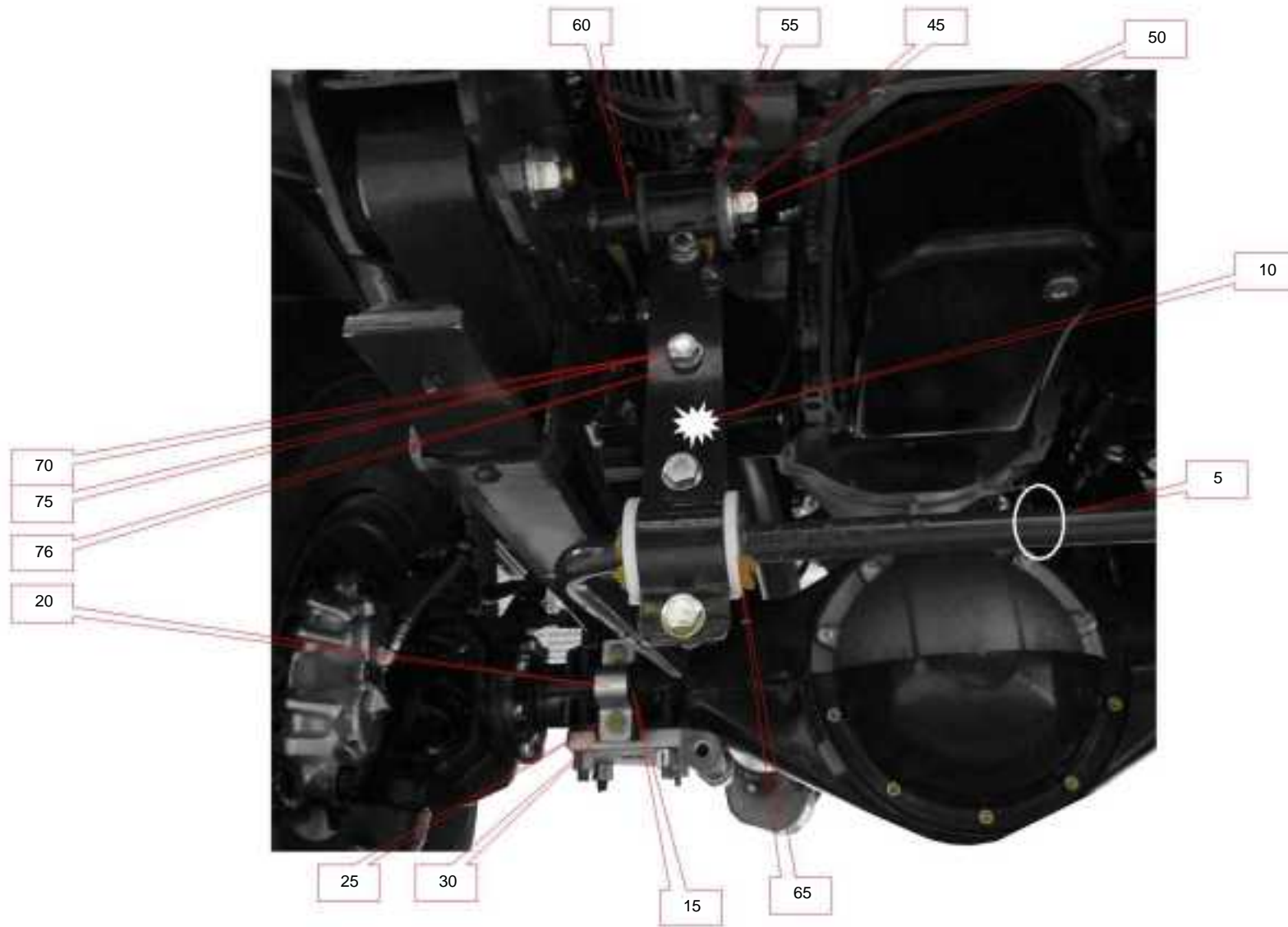

BARRA ANTERIORE

BREMACH

Pos	Codice	Descrizione	Q.tà
5	96B1000	BAR (BARRA STABIL. ANTER. DIAM. 22)	1
10	96B1002	ROD (BIELLA PER BARRA)	4
15	91B1020	DOWEL (TASSELLO IN GOMMA)	2
20	B6012	U BOLT (CAVALLOTTO BARRA TORS. PONTE ANTERIORE)	2
25	201041	SCREW (VITE M10X25)	4
30	203004	WASHER (RONDELLA D.10)	4
45	203125	WASHER (RONDELLA PIANA 18X48X4 UNI 6593 CAT. C)	2
50	16750621	NUT (DADO EF AUTOBL. M16)	2
55	91B1013	BUSH (BOCCOLA DI GOMMA)	2
60	91B1014	BUSH (BOCCOLA DISTANZIALE)	2
65	91B1023	BUSH (BOCCOLA IN NYLON DIAM. 22)	2
70	201075	SCREW (VITE M12 X 35)	10
75	202104	NUT (DADO AUTOBLOCCANTE M12)	10
76	76203005	WASHER (RONDELLA D.10)	10

BARRA ANTERIORE

BREMACH

BREMACH

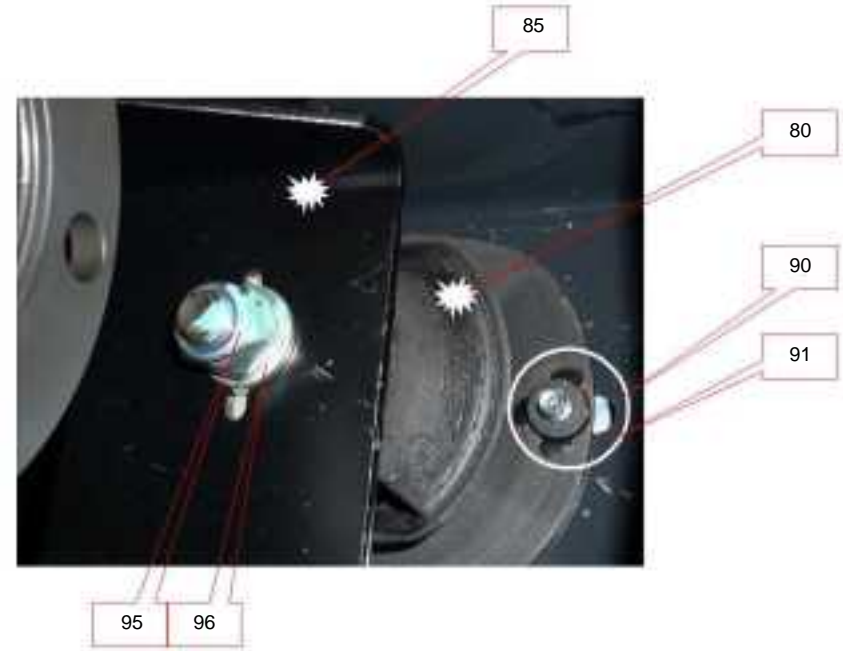
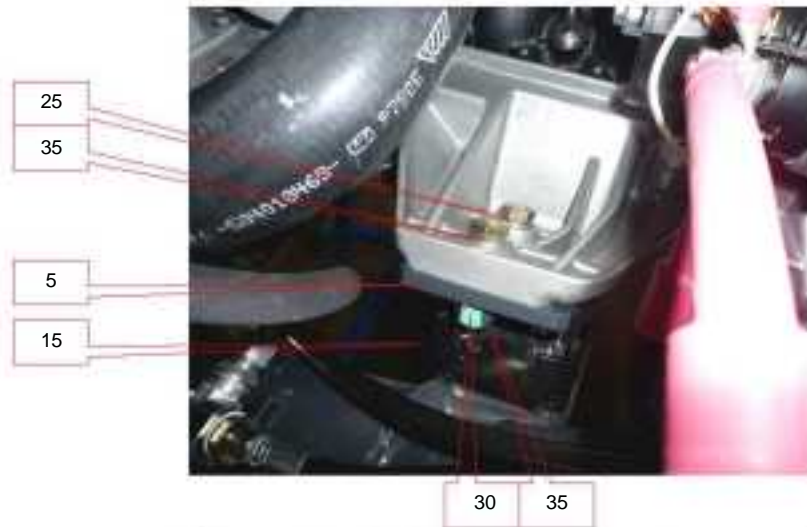

SOSPENSIONE MOTORE EURO 4 F1A

Pos	Codice	Descrizione	Q.tà
5	90N2001	SUPPORT (SOSTEGNO ANTER. RIDUTTORE)	2
5	96N2001D	BRACKET (MENSOLA ANTERIORE DX)	1
5	96N2001S	BRACKET (MENSOLA ANTERIORE SX)	1
15	91H2038D	DOWEL (TASSELLO ANTERIORE DX)	1
15	91H2038S	DOWEL (TASSELLO ANTERIORE SX)	1
25	201197	SCREW (VITE TE M12 X 50)	4
30	202104	NUT (DADO AUTOBLOCCANTE M12)	12
35	203005	COLLAR (ROSETTA D. 12)	16
50	96S3002	CROSS MEMBER (TRAVERSA SOST. CAMBIO ZF F1A)	1
55	201040	SCREW (VITE M10X20)	4
60	203004	WASHER (RONDELLA D.10)	4
80	91H3043	DOWEL (TASSELLO CAMBIO F1C)	1
85	91N2025	BRACKET (STAFFA POSTERIORE SOST. CAMBIO)	1
90	201021	SCREW (VITE M8X35)	2
91	203110	COLLAR (ROSETTA PIANA 8X24)	2
95	202104	NUT (DADO AUTOBLOCCANTE M12)	1
96	203005	COLLAR (ROSETTA D. 12)	1

BREMACH

BREMACH

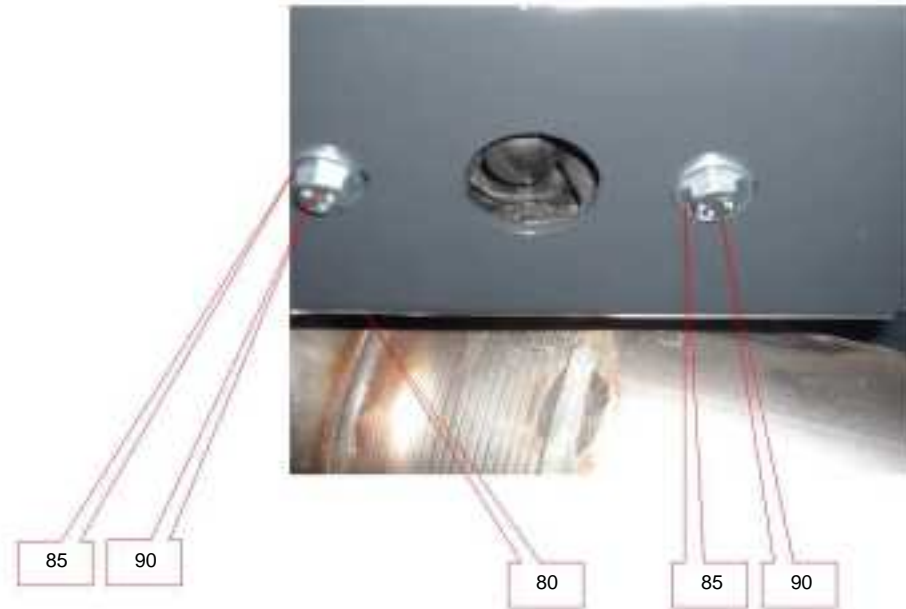

SOSPENSIONE MOTORE EURO 4 F1A

BREMACH

Pos	Codice	Descrizione	Q.tà
80	91H3043	DOWEL (TASSELLO CAMBIO F1C)	1
85	91N2025	BRACKET (STAFFA POSTERIORE SOST. CAMBIO)	1
90	201021	SCREW (VITE M8X35)	2

SOSPENSIONE MOTORE EURO 4 F1A

BREMACH

BREMACH

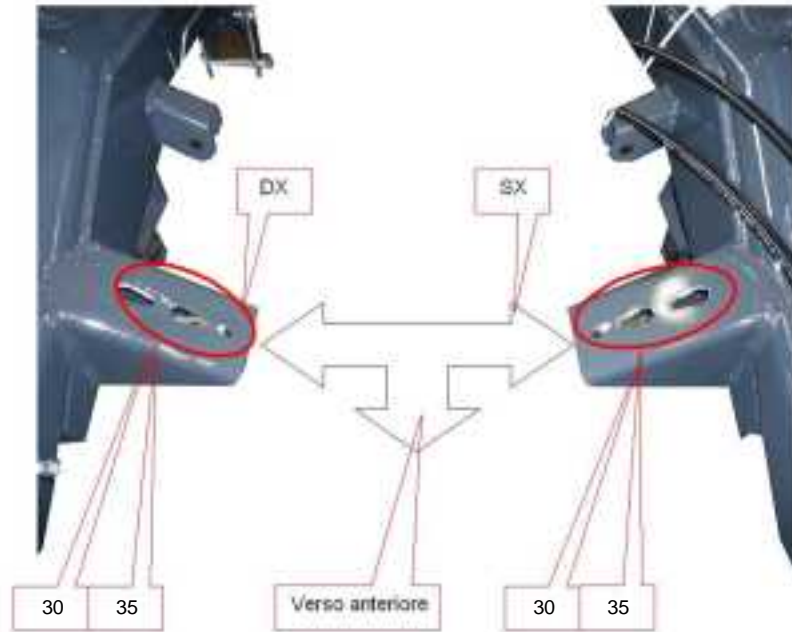

SOSPENSIONE MOTORE EURO 4 F1C

BREMACH

Pos	Codice	Descrizione	Q.tà
30	202104	NUT (DADO AUTOBLOCCANTE M12)	4
35	203005	COLLAR (ROSETTA D. 12)	4

SOSPENSIONE MOTORE EURO 4 F1C

BREMACH

BREMACH



SOSPENSIONE MOTORE EURO 4 F1C

BREMACH

Pos	Codice	Descrizione	Q.tà
5	QT1515	BRACKET (MENSOLA ANTERIORE DX F1C 146 CV)	1
6	96N2007D	BRACKET (MENSOLA ANTERIORE DX F1C176CV)	1
10	96N2007S	BRACKET (MENSOLA ANTERIORE SX F1C176 CV)	1
10	QT1516	BRACKET (MENSOLA ANTERIORE SX F1C 146 CV)	1
15	91H2038D	DOWEL (TASSELLO ANTERIORE DX)	1
20	91H2038S	DOWEL (TASSELLO ANTERIORE SX)	1
25	201042	SCREW (VITE M10X30)	8
26	203004	WASHER (RONDELLA D.10)	8
27	203005	COLLAR (ROSETTA D. 12)	8
28	201197	SCREW (VITE TE M12 X 50)	4
29	202104	NUT (DADO AUTOBLOCCANTE M12)	4
30	202104	NUT (DADO AUTOBLOCCANTE M12)	4
35	203005	COLLAR (ROSETTA D. 12)	4

SOSPENSIONE MOTORE EURO 4 F1C

BREMACH

BREMACH

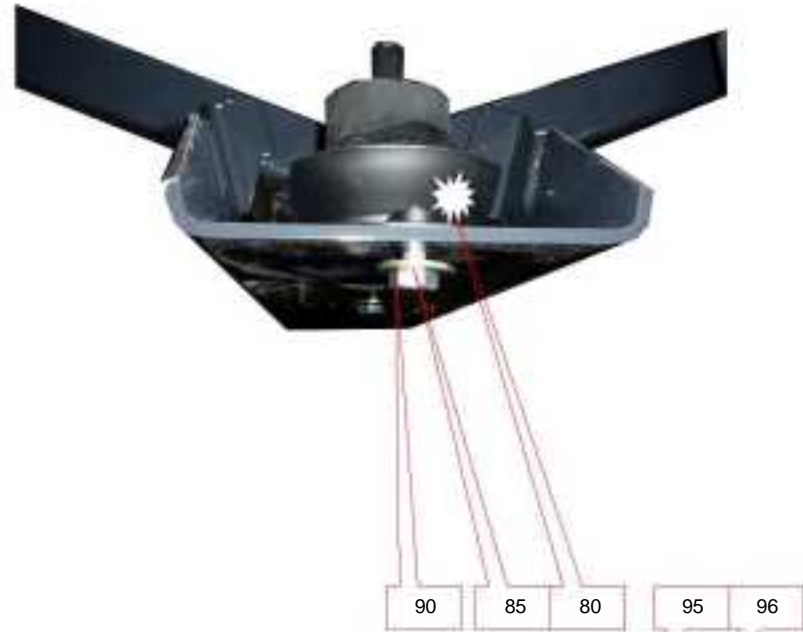

SOSPENSIONE MOTORE EURO 4 F1C

Pos	Codice	Descrizione	Q.tà
50	QT1517	CROSS MEMBER (TRAVERSA SOST. CAMBIO ZF F1C)	1
65	91N2025	BRACKET (STAFFA POSTERIORE SOST. CAMBIO)	1
70	201040	SCREW (VITE M10X20)	4
75	203004	WASHER (RONDELLA D.10)	4
80	91H3043	DOWEL (TASSELLO CAMBIO F1C)	1
85	201021	SCREW (VITE M8X35)	2
90	203110	COLLAR (ROSETTA PIANA 8X24)	2
95	201041	SCREW (VITE M10X25)	4
96	203004	WASHER (RONDELLA D.10)	4

BREMACH

BREMACH



5



12

10



55



60

65

MOTORE 85 Kw F1A

Pos	Codice	Descrizione	Q.tà
5	91H1060	ENGINE (MOTORE 85 KW 6M B/E (F1A))	1
5	91H1070	ENGINE (MOTORE 107 KW 6M (F1C))	1
5	96H1014	ENGINE (MOTORE 130 KW 6M (F1C))	1
10	91H1061	VALVE (ELETTRIVALVOLA EGR F1A)	1
12	91H1071	FILTER (FILTRO PER ELETTRIVALVOLA EGR)	1
55	91H1062	SPACER (DISTANZIALE PER VENTOLA MOTORE F1A)	1
60	91H1084	FAN (VENTOLA MOT. F1A)	1
65	91H1097	FAN (VENTOLA MOT. F1C)	1

MOTORE 85 Kw F1A

BREMACH

BREMACH



15



20



50

45



15

MOTORE 85 Kw F1A

Pos	Codice	Descrizione	Q.tà
15	95L5000	KIT (KIT IDRAULICO FRIZIONE)	1
20	96H1003	GROUP (GRUPPO RINVIO CAMBIO COMPL.)	1
45	96H1007	LEVER (LEVA CAMBIO)	1
50	96H1008	LEVER (LEVA CAMBIO)	1

BREMACH

BREMACH

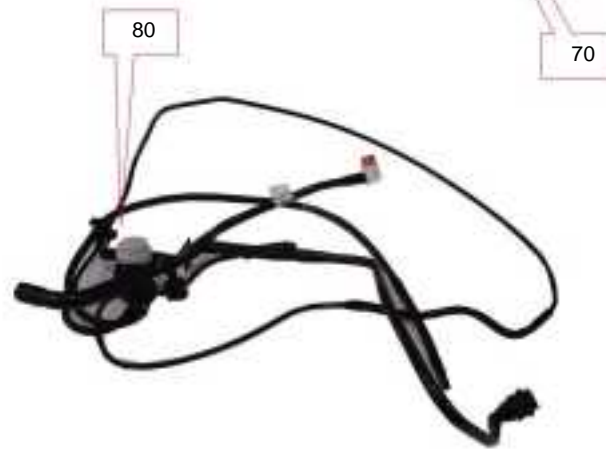

MOTORE 85 Kw F1A

Pos	Codice	Descrizione	Q.tà
70	91H1077	GEARCASE (CENTRALINA PRERISCALDO)	1
75	96H1017	VALVE (ELETTROVALVOLA EGR 176 CVF1C)	1
80	91H1081	VALVE (ELETTROVALVOLA EGR 146 CVF1C)	1

BREMACH

BREMACH

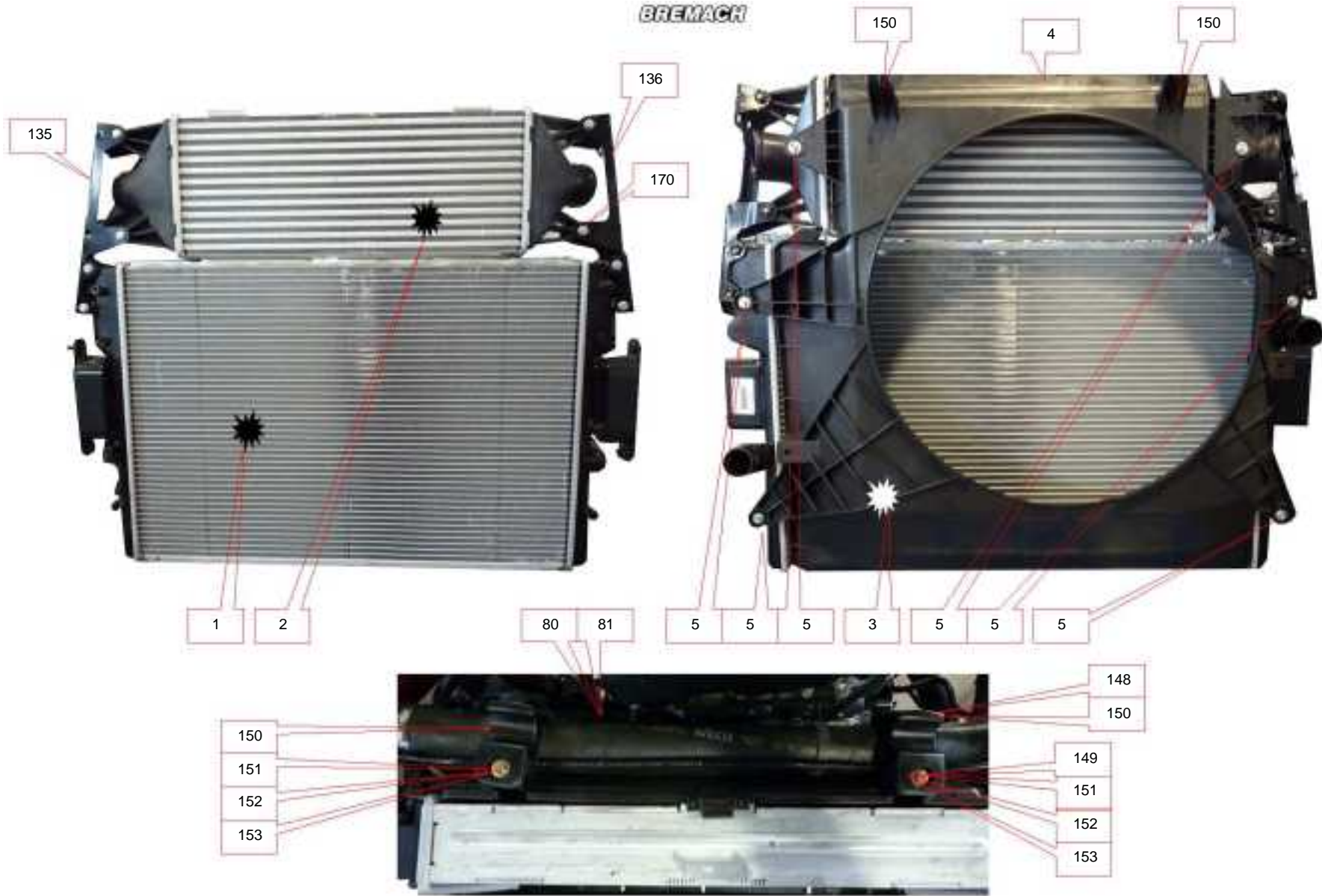

RAFFREDDAMENTO MOTORE E4 F1C

BREMACH

Pos	Codice	Descrizione	Q.tà
1	91H2050	RADIATOR (RADIATORE ACQUA F1C)	1
2	96H9203	RADIATOR (RADIATORE ARIA F1C M.Y. 08)	1
3	96H2003	GUIDE HOOD (CONVOGLIATORE ARIA INT. (F1C) M.Y.08)	1
4	96H2009	RUBBER (GOMMINO)	1
5	16883405	SCREW (VITE AUTOF.M6 FISS.CONVOGL.)	6
80	91H4038	SLEEVE (MANICOTTO SUPERIORE RADIATORE F1C)	1
81	96H4007	SLEEVE (MANICOTTO SUPERIORE RADIATORE F1A)	1
135	96H2007D	BRACKET (STAFFA DX SUPPORTO RADIATORE F1C)	1
136	96H2007S	BRACKET (STAFFA SX SUPPORTO RADIATORE F1C)	1
148	96H2014	BRACKET (STAFFA PER F1A)	2
149	16772804	SCREW (VITE M6X16)	4
150	96H2011	BRACKET (STAFFA PER RADIATORE)	2
151	203102	WASHER (RONDELLA PIANA 5X16X1,6)	2
152	202002	NUT (DADO M5)	2
153	201004	SCREW (VITE M5X25)	2
170	18139124	VITE TEF M6X70	8

RAFFREDDAMENTO MOTORE E4 F1C

BREMACH

BREMACH



149

200



148



F1A

RAFFREDDAMENTO MOTORE E4 F1C

BREMACH

Pos	Codice	Descrizione	Q.tà
148	96H2014	BRACKET (STAFFA PER F1A)	2
149	16772804	SCREW (VITE M6X16)	4
200	96H2012	BRACKET (STAFFA BLOCCAGGIO TUBO F1C)	2

RAFFREDDAMENTO MOTORE E4 F1C

BREMACH

BREMACH

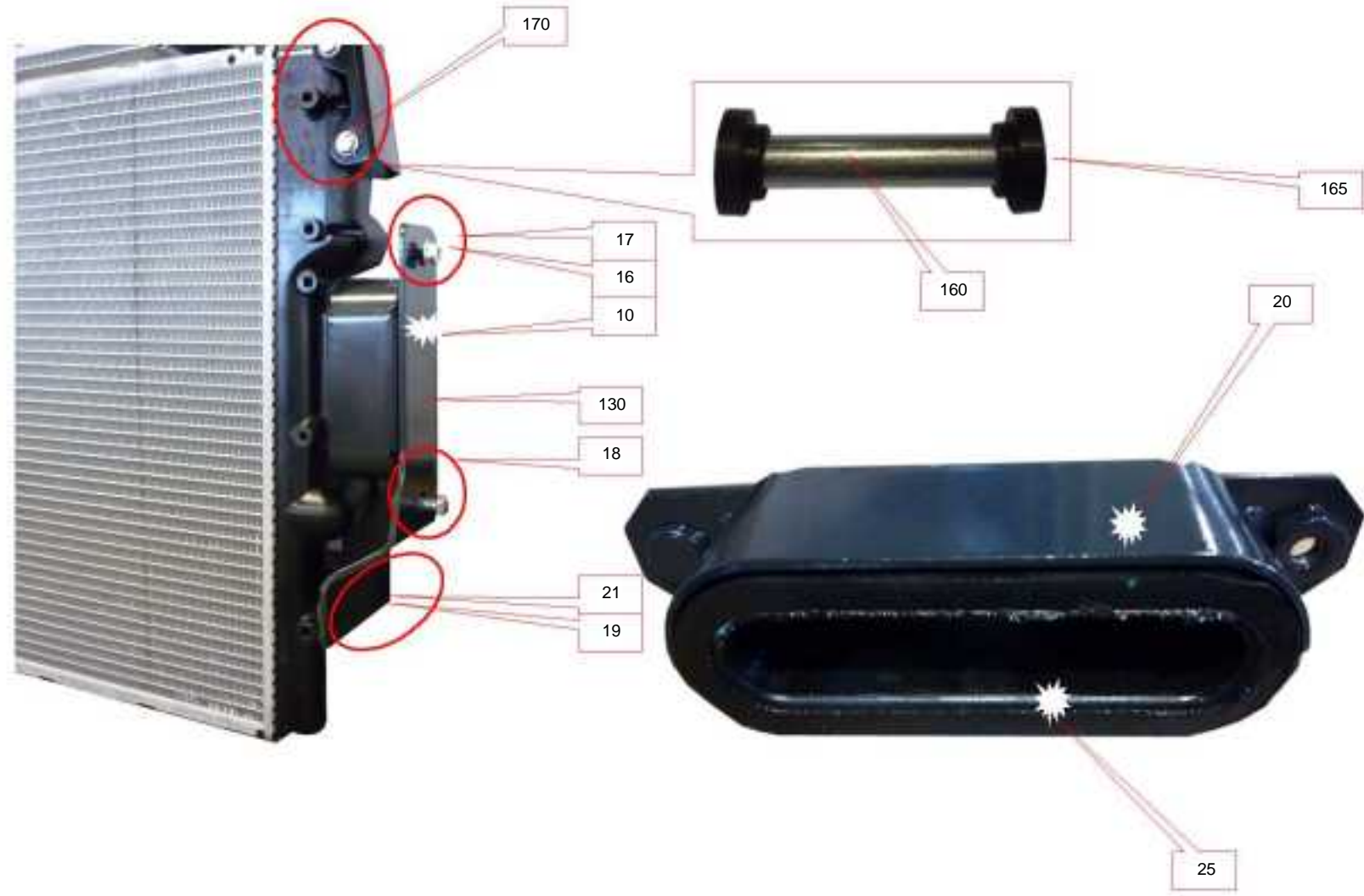

RAFFREDDAMENTO MOTORE E4 F1C

BREMACH

Pos	Codice	Descrizione	Q.tà
10	96H2022D	BRACKET (STAFFA DX SOST. RADIATORE M.Y. 08 F1C)	1
10	96H2022S	BRACKET (STAFFA SX SOST. RADIATORE M.Y. 08 F1C)	1
10	96H2023D	BRACKET (STAFFA DX SOST. RADIATORE M.Y. 08 F1A)	1
10	96H2023S	BRACKET (STAFFA SX SOST. RADIATORE M.Y. 08 F1A)	1
16	203110	COLLAR (ROSETTA PIANA 8X24)	4
17	202004	NUT (DADO M8)	4
18	201021	SCREW (VITE M8X35)	2
19	203003	COLLAR (ROSETTA CON. EL. 8X16X1,9)	4
20	94H2007	SUPPORT (SUPPORTO TASSELLO ELASTICO)	2
21	201021	SCREW (VITE M8X35)	4
25	94H2008	DOWEL (TASSELLO ELASTICO)	2
130	96H2007S	BRACKET (STAFFA SX SUPPORTO RADIATORE F1C)	1
160	95H2018	SPACER (DISTANZIALE)	4
165	95H2008	DOWEL (TASSELLO FISSAGGIO RAD./INTERC.)	8
170	18139124	VITE TEF M6X70	8

RAFFREDDAMENTO MOTORE E4 F1C

BREMACH

BREMACH

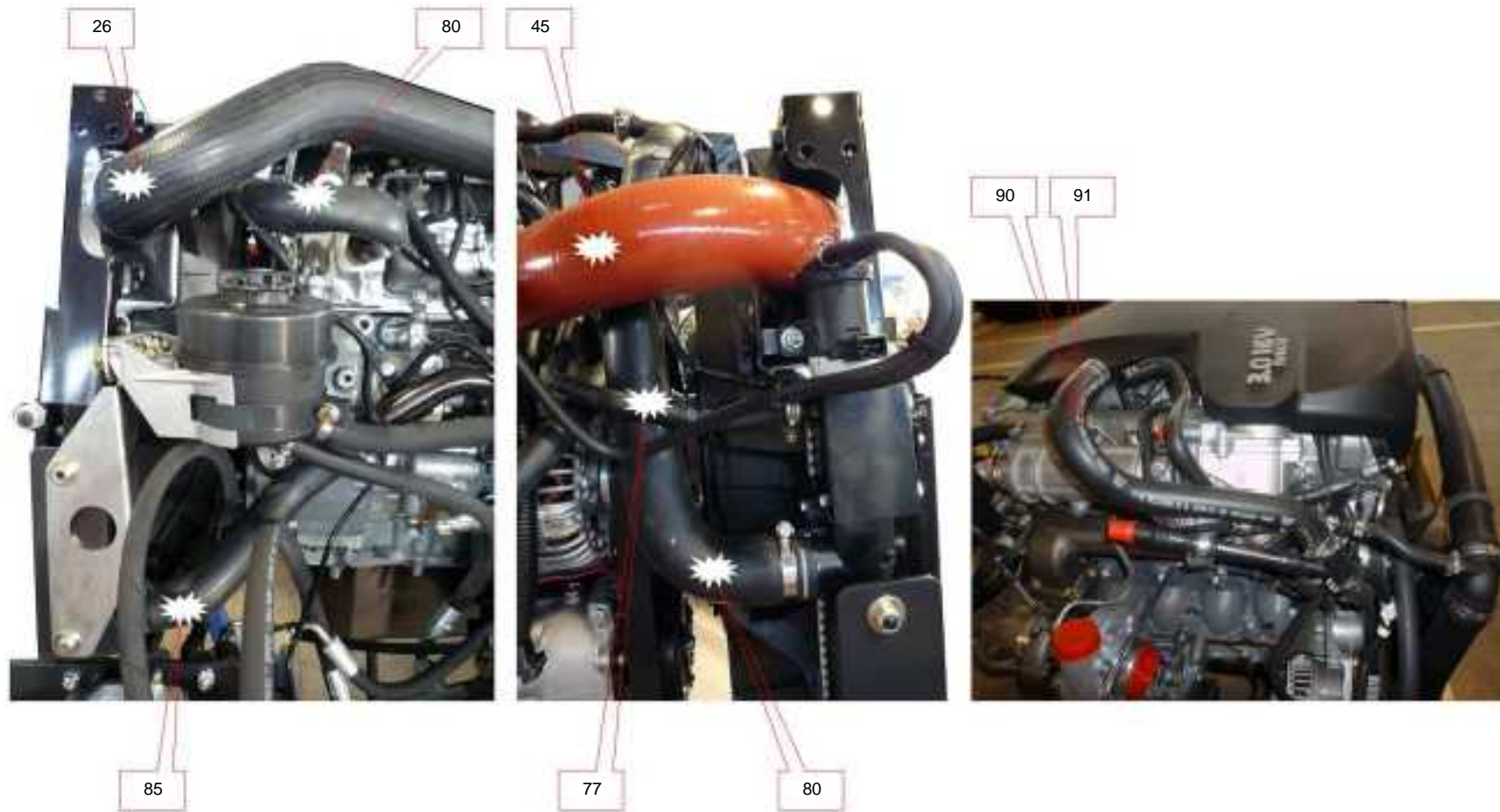

RAFFREDDAMENTO MOTORE E4 F1C

Pos	Codice	Descrizione	Q.tà
26	96H2010	SLEEVE (MANICOTTO GOMMA F1C)	1
45	96H2005	SLEEVE (MANICOTTO GOMMA F1C)	1
77	91H4053	TUBE (TUBO SFIATO MOTORE-RADIATORE F1C)	1
80	91H4038	SLEEVE (MANICOTTO SUPERIORE RADIATORE F1C)	1
85	91H4039	SLEEVE (MANICOTTO INFER. RADIATORE F1C)	1
90	96H4002	SLEEVE (MANICOTTO)	1
91	96H4008	SLEEVE (MANICOTTO)	1

BREMACH

BREMACH



85

F1A



77

RAFFREDDAMENTO MOTORE E4 F1C

BREMACH

Pos	Codice	Descrizione	Q.tà
77	91H4053	TUBE (TUBO SFIATO MOTORE-RADIATORE F1C)	1
85	91H4039	SLEEVE (MANICOTTO INFER. RADIATORE F1C)	1

RAFFREDDAMENTO MOTORE E4 F1C

BREMACH

BREMACH

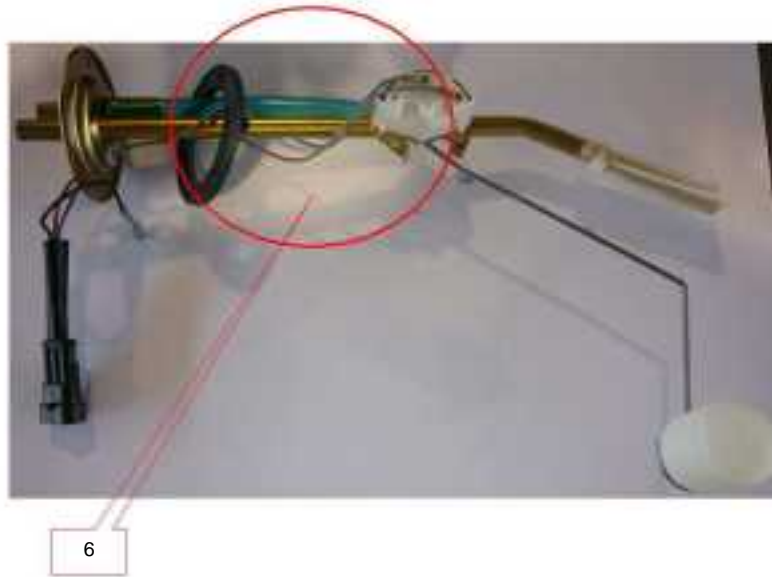
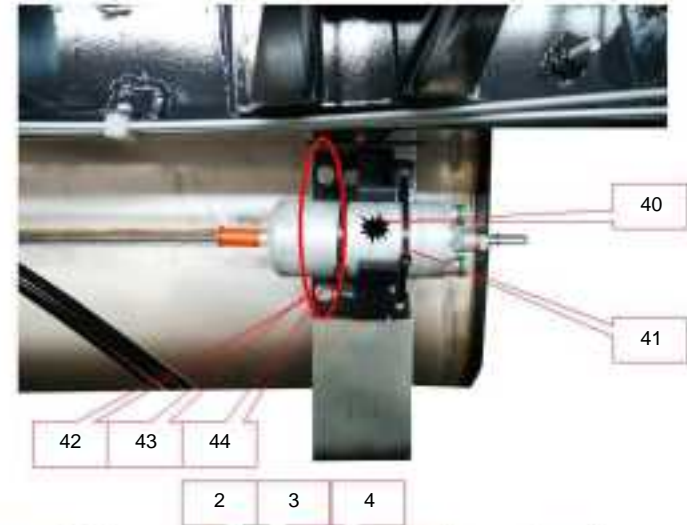

SERBATOIO COMBUSTIBILE

Pos	Codice	Descrizione	Q.tà
2	201023	SCREW (VITE M8X30 UNI 5739-65 ZINCOTR)	2
3	16750221	NUT (DADO EF M8)	2
4	203003	COLLAR (ROSETTA CON. EL. 8X16X1,9)	2
5	90H5000	TANK (SERBATOIO GASOLIO LT 90 PER CAB. DOPPIA BOCCHETTONE DX)	1
5	90H5041	TANK (SERBATOIO GASOLIO LT 70 PER CAB. SING. BOCCHETTONE SX)	1
5	90H5042	TANK (SERBATOIO GASOLIO LT 70 PER CAB. DOPPIA BOCCHETTONE)	1
5	91H5020	TANK (SERBATOIO GASOLIO LT 140 PER CABINA SINGOLA)	1
6	90H5038	GROUP (GRUPPO GALLEGGIANTE)	1
7	90H5035	CAP (TAPPO SERBATOIO SENZA CHIAVE)	1
40	91H5026	PRE-PUMP (PREPOMPA COMBUSTIBILE)	1
41	Z270009	CLAMP (FASCETTA NYLON 4,8X290)	2
42	201021	SCREW (VITE M8X35)	2
43	203003	COLLAR (ROSETTA CON. EL. 8X16X1,9)	2
44	16750221	NUT (DADO EF M8)	2

SERBATOIO COMBUSTIBILE

BREMACH

BREMACH



10



25

30



15

20



35

36

SERBATOIO COMBUSTIBILE

BREMACH

Pos	Codice	Descrizione	Q.tà
10	90N2011	BRACKET (STAFFA SUP. SERBATOIO GASOLIO)	2
15	A1023	PROFILE (PROFILO AMMORTIZZATORE FASCIA SERBATOIO)	2
20	90N2012	BAND (FASCIA FISSAGGIO SERBATOIO GASOLIO)	2
25	201020	SCREW (VITE M8X16)	8
30	203003	COLLAR (ROSETTA CON. EL. 8X16X1,9)	8
35	202004	NUT (DADO M8)	2
36	203003	COLLAR (ROSETTA CON. EL. 8X16X1,9)	2

SERBATOIO COMBUSTIBILE

BREMACH

BREMACH



40



45 50



55



80

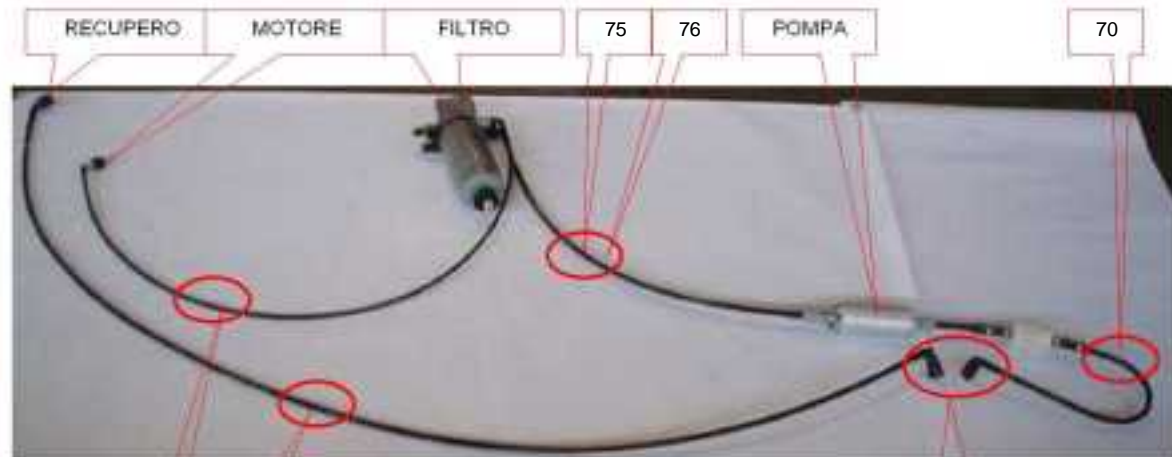

RECUPERO

MOTORE

FILTRO

75

76

POMPA

70

100

91

SERBATOIO

SERBATOIO COMBUSTIBILE

Pos	Codice	Descrizione	Q.tà
40	91H5026	PRE-PUMP (PREPOMPA COMBUSTIBILE)	1
45	91H5003	PIPE SOCKET (RACCORDO TUBO GASOLIO SU POMPA ELETTR.)	1
50	91H5012	SEAL (GUARNIZIONE RACCORDO GASOLIO POMPA ELETTR.)	1
55	91H5027	BRACKET (STAFFA FISSAGGIO PREPOMPA)	1
70	91H5002	TUBE (TUBO GASOLIO SERBATOIO/POMPA ELETTR. CS)	1
70	95H5001	TUBE (TUBO GASOLIO SERBATOIO/POMPA ELETTR. CS 140 L.)	1
75	91H5016	TUBE (TUBO DA POMPA ELETTR. A FILTRO)	1
76	96H3003	BRACKET (STAFFA FISS. TUBO SCARICO F1C)	1
80	91H5025	FILTER (FILTRO GASOLIO)	1
91	91H5017	TUBE (TUBO GASOLIO RECUPERO SERBATOIO C. SING.)	1
91	95H5005	TUBE (TUBO GASOLIO RECUPERO SERBATOIO C. DOPPIA)	1
100	91H5028	TUBE (TUBO GASOLIO DA MOTORE A FILTRO)	1

SERBATOIO COMBUSTIBILE

BREMACH

BREMACH

1



VASO ESPANSIONE E TUBAZIONI

BREMACH

Pos	Codice	Descrizione	Q.tà
1	91H2002	TANK (VASCHETTA LIQUIDO DI RAFFR. F1C)	1
1	91H2045	TANK (VASCHETTA LIQUIDO DI RAFFR. F1A)	1

VASO ESPANSIONE E TUBAZIONI

BREMACH

BREMACH

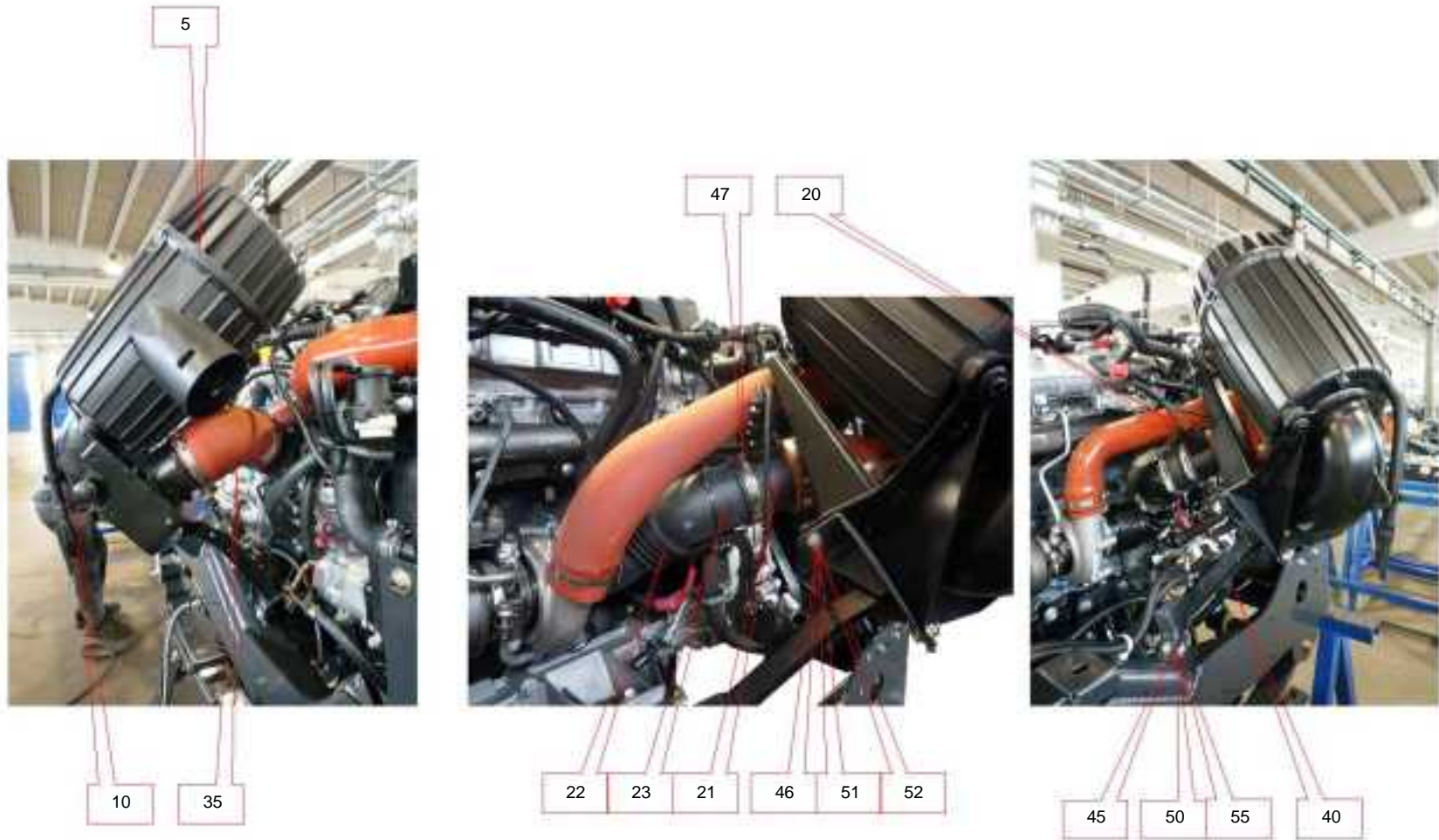

PRESA ARIA MOTORE E4 F1C

BREMACH

Pos	Codice	Descrizione	Q.tà
5	91H4049	FILTER (FILTRO ARIA COMPLETO F1C)	1
10	91H4022	INDICATOR (INDICATORE FILTRO ARIA INTASATO)	1
20	91H4034	DEBIMETER (DEBIMETRO)	1
21	96H4011	PIPELINE (TUBAZIONE COLL. DEBIM. - TURBO - F1C)	1
22	91H4052	PIPELINE (TUBAZIONE ARIA DA TURB. A FILTRO F1C)	1
23	91H4048	SLEEVE (MANICOTTO DI COLLEGAMENTO)	1
35	96H4005	SLEEVE (MANICOTTO ASPIR. ENTR. COMPRESS.)	1
40	96H4006	BRACKET (STAFFA SUPPORTO FILTRO ARIA)	1
45	201042	SCREW (VITE M10X30)	2
46	201021	SCREW (VITE M8X35)	3
47	17765193	COLLAR (COLLARE A NASTRO)	4
50	203004	WASHER (RONDELLA D.10)	4
51	16750221	NUT (DADO EF M8)	3
52	203003	COLLAR (ROSETTA CON. EL. 8X16X1,9)	3
55	202103	NUT (DADO AUTOBLOCC M10)	2

PRESA ARIA MOTORE E4 F1C

BREMACH

BREMACH



PRESA ARIA MOTORE E4 F1C

BREMACH

Pos	Codice	Descrizione	Q.tà
5	91H4049	FILTER (FILTRO ARIA COMPLETO F1C)	1
10	91H4022	INDICATOR (INDICATORE FILTRO ARIA INTASATO)	1
20	91H4034	DEBIMETER (DEBIMETRO)	1
22	91H4052	PIPELINE (TUBAZIONE ARIA DA TURB. A FILTRO F1C)	1
24	96H4025	ANELLO	4
30	91H4036	PLUG (PRESA FILTRO ARIA F1A)	1

PRESA ARIA MOTORE E4 F1C

BREMACH

BREMACH

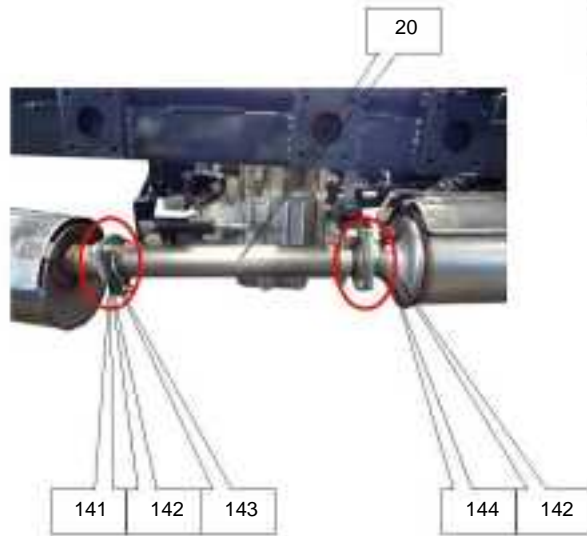
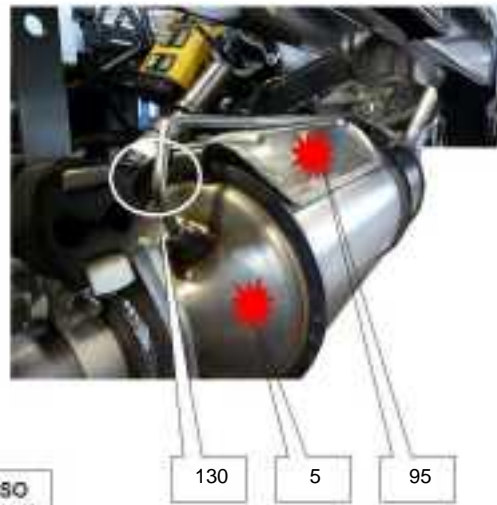
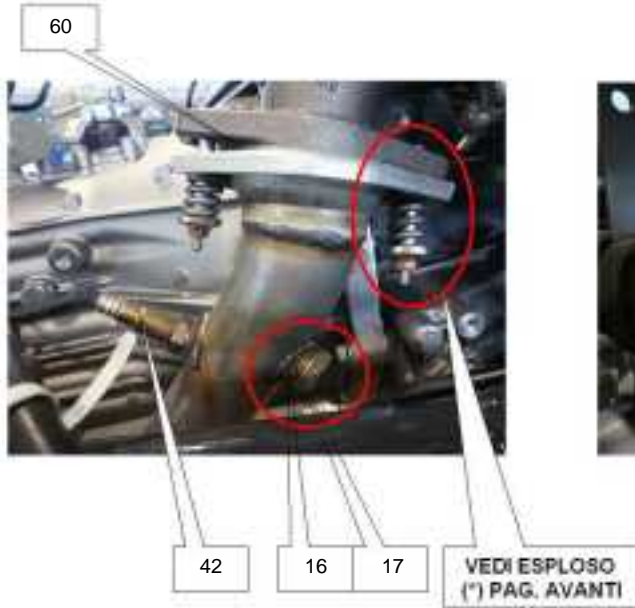

TUBAZIONE DI SCARICO

Pos	Codice	Descrizione	Q.tà
5	91H3035	CATALYST (CATALIZZATORE)	1
5	91H3046	FILTER (FILTRO ANTIPARTICOLATO)	1
10	91H3034	SILENCER (SILENZIATORE)	1
10	91H3047	SILENCER (SILENZIATORE F1C)	1
16	80489	CAP (TAPPO)	1
17	91D1034	ROSETTA IN RAME	9
20	96H3002	TUBE (TUBO DA FAP A SILENZIATORE)	1
42	91H3039	FEELER (SONDA LAMBDA)	1
60	95H3010	RING (ANELLO GUARNIZIONE)	1
95	91H3054	PROTECTION (PROTEZIONE PER FAP)	1
110	91H3055	PROTECTION (RIPARO PER SILENZIATORE)	1
130	91H3061	TUBE (TUBO SU FAP)	1
135	90H9301	WHOLE (ASSIEME SUPPORTO SILENZIATORE)	1
141	201044	SCREW (VITE M10X45)	2
142	203004	WASHER (RONDELLA D.10)	4
143	202005	NUT (DADO M10)	2
144	201042	SCREW (VITE M10X30)	2

TUBAZIONE DI SCARICO

BREMACH

BREMACH

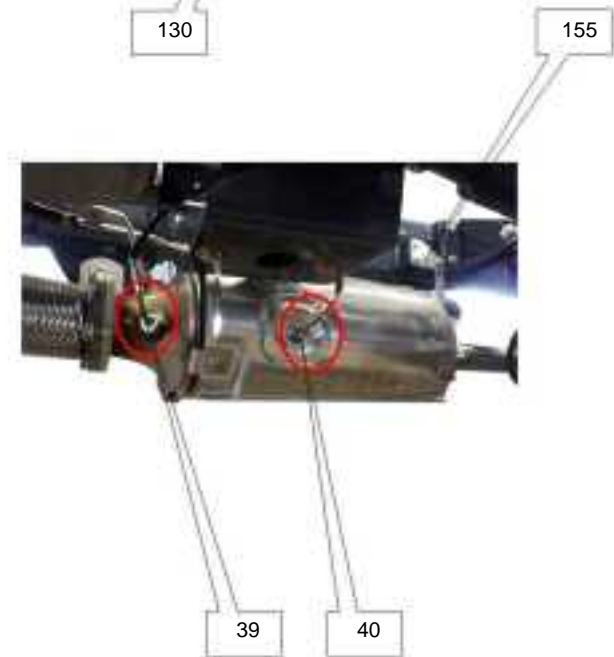
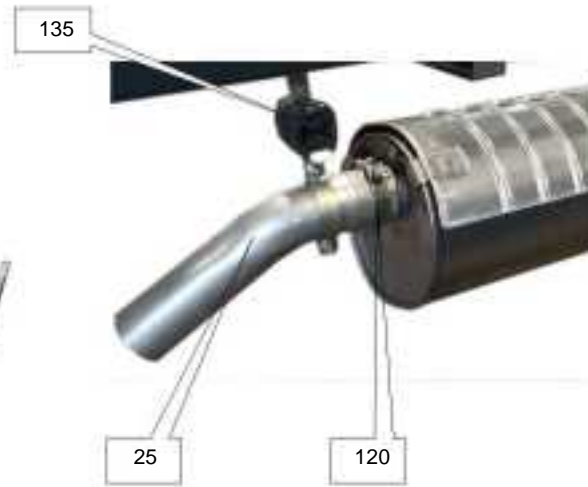
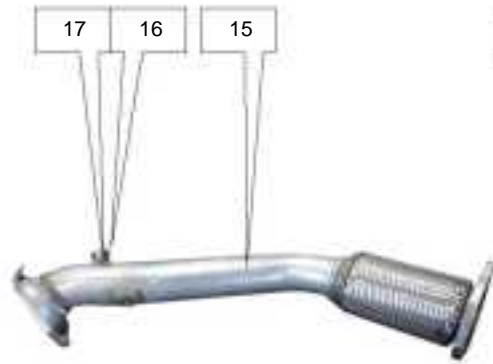

TUBAZIONE DI SCARICO

Pos	Codice	Descrizione	Q.tà
15	96H3006	TUBE (TUBO DA MOTORE A FAP F1C)	1
16	80489	CAP (TAPPO)	1
17	91D1034	ROSETTA IN RAME	9
25	90H3038	TUBE (TUBO DI SCARICO FINALE F1A)	1
25	91H3048	TUBE (TUBO DI SCARICO FINALE F1C)	1
39	91H3053	SENSOR (SENSORE FAP)	1
40	91H3052	SENSOR (SENSORE FAP)	1
42	91H3039	FEELER (SONDA LAMBDA)	1
120	91H3059	COLLAR (COLLARE DI SERRAGGIO)	1
130	91H3061	TUBE (TUBO SU FAP)	1
135	90H9301	WHOLE (ASSIEME SUPPORTO SILENZIATORE)	1
155	96H3003	BRACKET (STAFFA FISS. TUBO SCARICO F1C)	1

TUBAZIONE DI SCARICO

BREMACH

BREMACH

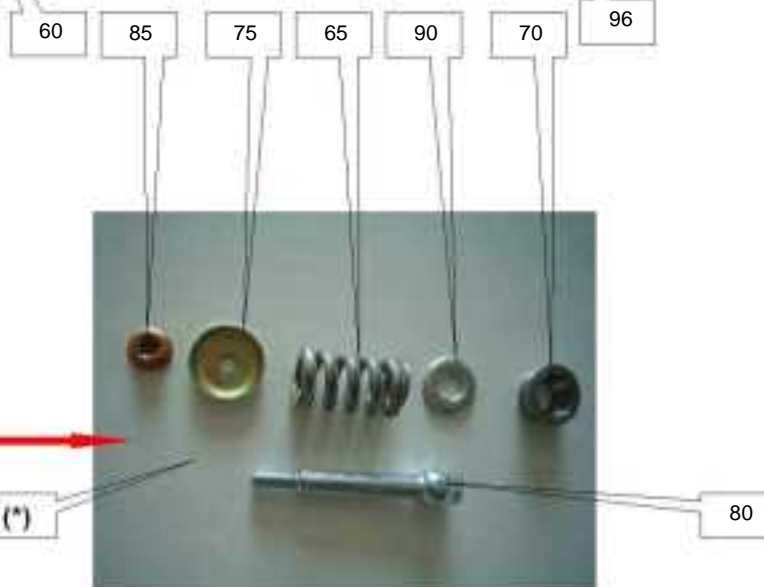

TUBAZIONE DI SCARICO

BREMACH

Pos	Codice	Descrizione	Q.tà
41	91H3058	SENSOR (SENSORE FAP)	1
60	95H3010	RING (ANELLO GUARNIZIONE)	1
65	95H3012	SPRING (MOLLA)	2
70	95H3011	BUSH (BOCCOLA)	2
75	95H3008	COVER (COPERCHIO)	2
80	95H3013	SCREW (VITE)	2
85	202213	NUT (DADO M6X1,25 FE/CU)	2
90	95H3016	WASHER (RONDELLA)	2
96	96H3012	TUBE (TUBO GOMMA SENSORE FAP)	2
100	18088192	COLLAR (COLLARE A NASTRO 10-16)	4

TUBAZIONE DI SCARICO

BREMACH

BREMACH

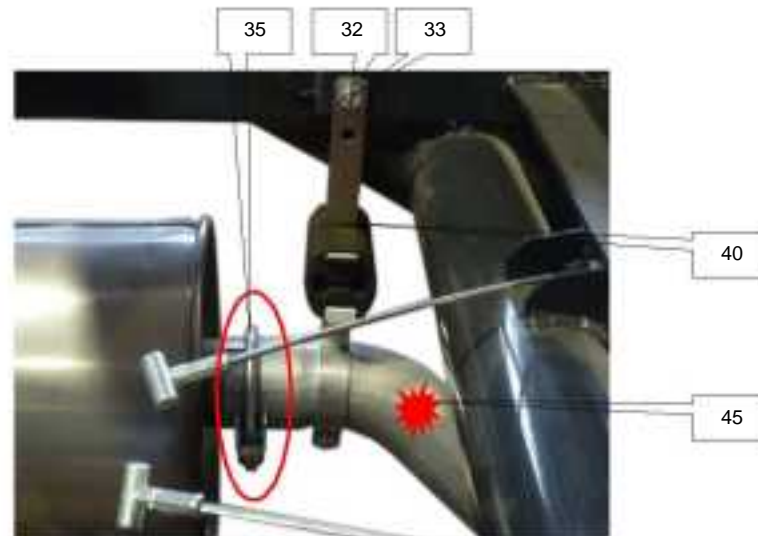
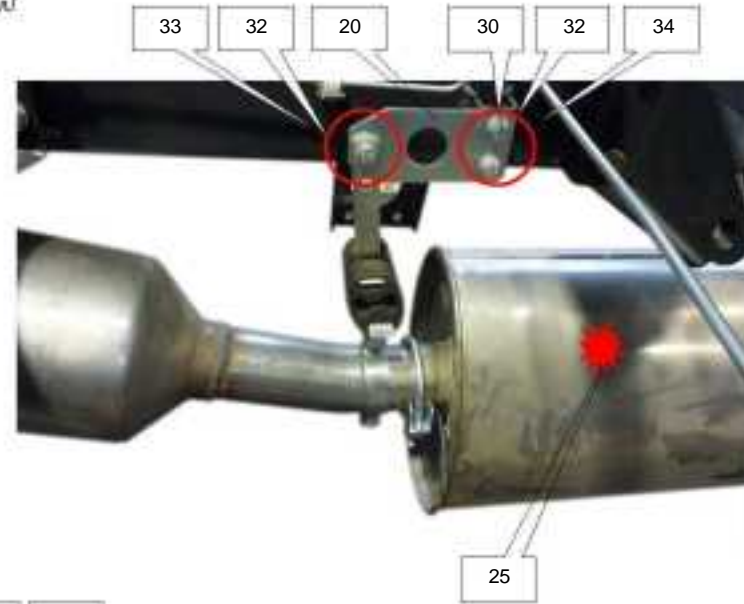
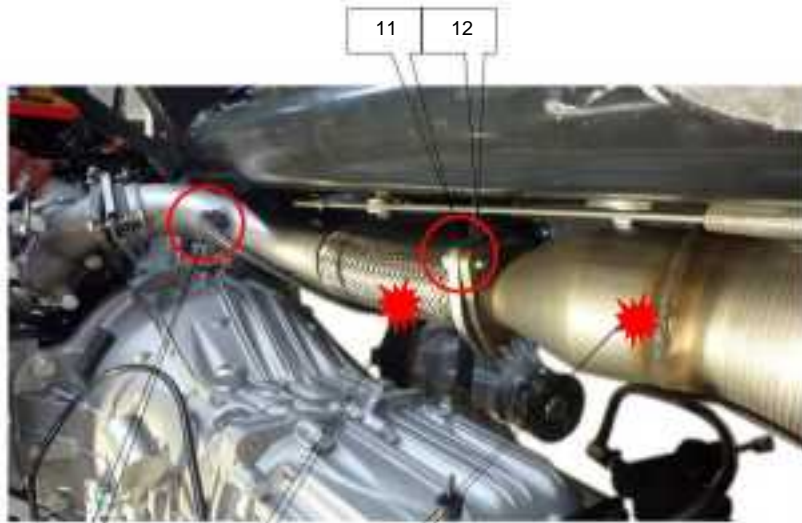

TUBAZIONE DI SCARICO

BREMACH

Pos	Codice	Descrizione	Q.tà
5	91H3039	FEELER (SONDA LAMBDA)	1
10	91H3005	TUBE (TUBO)	1
11	201041	SCREW (VITE M10X25)	1
12	203004	WASHER (RONDELLA D.10)	4
15	91H3035	CATALYST (CATALIZZATORE)	1
20	96H3004	BRACKET (STAFFA)	1
25	91H3034	SILENCER (SILENZIATORE)	1
30	201021	SCREW (VITE M8X35)	1
32	203003	COLLAR (ROSETTA CON. EL. 8X16X1,9)	4
33	201022	SCREW (VITE M8X25)	2
34	16750221	NUT (DADO EF M8)	2
35	90H3136	CLAMP (FASCETTA 10-65)	2
40	90H9301	WHOLE (ASSIEME SUPPORTO SILENZIATORE)	1
45	91H3038	TERMINAL (TERMINALE)	1

TUBAZIONE DI SCARICO

BREMACH

BREMACH

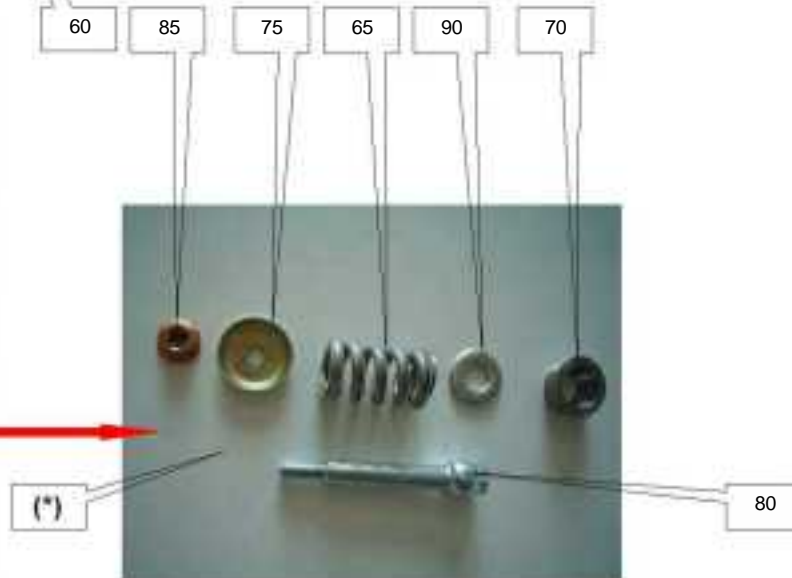

TUBAZIONE DI SCARICO

BREMACH

Pos	Codice	Descrizione	Q.tà
60	95H3010	RING (ANELLO GUARNIZIONE)	1
65	95H3012	SPRING (MOLLA)	2
70	95H3011	BUSH (BOCCOLA)	2
75	95H3008	COVER (COPERCHIO)	2
80	95H3013	SCREW (VITE)	2
85	202213	NUT (DADO M6X1,25 FE/CU)	2
90	95H3016	WASHER (RONDELLA)	2

TUBAZIONE DI SCARICO

BREMACH

BREMACH

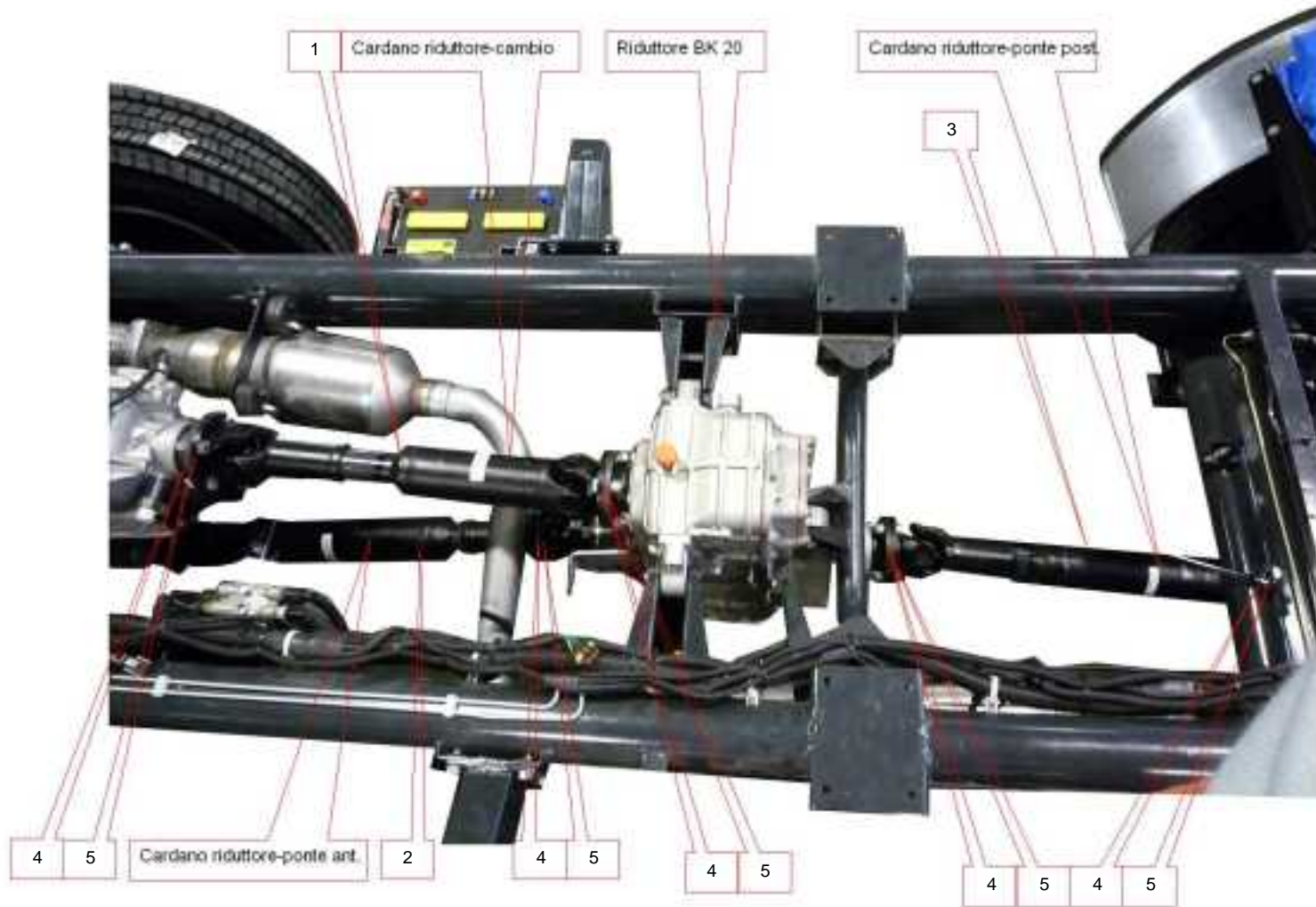

ALBERI TRASMISSIONE

Pos	Codice	Descrizione	Q.tà
1	96C1000	CARDAN JOINT (CARDANO CAMBIO-RIDUTTORE 430/510 F1C)	1
1	96C1001	CARDAN JOINT (CARDANO CAMBIO-RIDUTTORE 480/560 F1A)	1
1	96C1016	CARDAN JOINT (CARDANO CAMBIO AUTOM.-RIDUTTORE)	1
2	90C1004	CARDAN JOINT (CARDANO RIDUTTORE-PONTE ANTER. 795/865)	1
3	96C1002	CARDAN JOINT (CARDANO RIDUTTORE-PONTE POSTERIORE 1160/1240)	1
3	96C1006	CARDAN JOINT (CARDANO RIDUTTORE-PONTE POSTERIORE 660/740)	1
3	96C1007	CARDAN JOINT (CARDANO RIDUTTORE-PONTE POSTERIORE 1510/1590)	1
4	201075	SCREW (VITE M12 X 35)	24
5	202104	NUT (DADO AUTOBLOCCANTE M12)	24

BREMACH

BREMACH

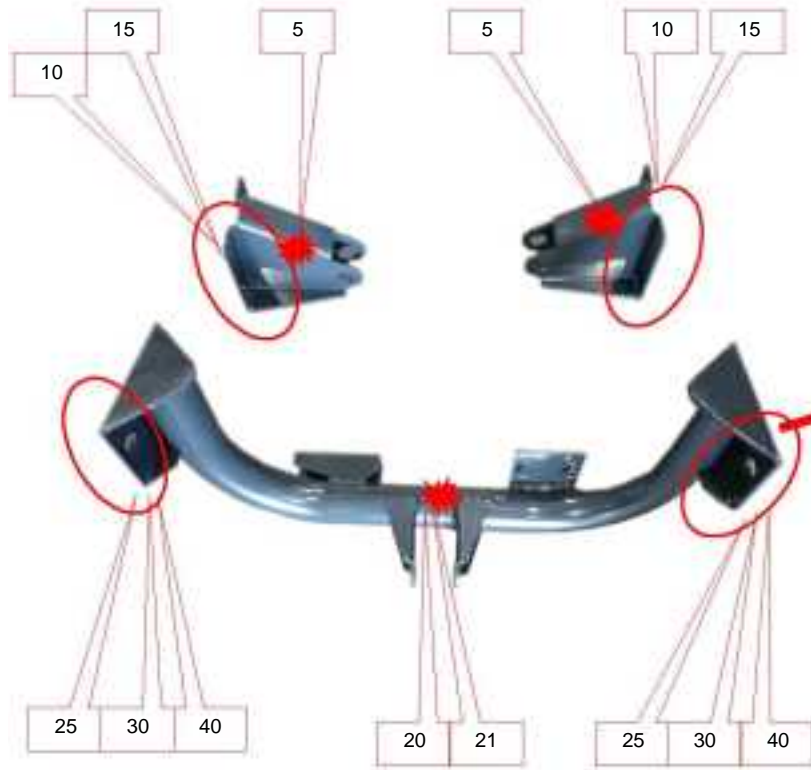

RIDUTTORE

Pos	Codice	Descrizione	Q.tà
5	90N2001	SUPPORT (SOSTEGNO ANTER. RIDUTTORE)	2
10	201041	SCREW (VITE M10X25)	8
15	203004	WASHER (RONDELLA D.10)	8
20	96N2003	WHOLE (ASSIEME SUPPORTO POSTERIORE RID.)	1
21	90N2005	WHOLE (ASSIEME SUPPORTO POSTERIORE VERSIONE BASIC)	1
25	201041	SCREW (VITE M10X25)	4
30	203004	WASHER (RONDELLA D.10)	4
40	16750621	NUT (DADO EF AUTOBL. M16)	3

BREMACH

BREMACH

45



5



DIFFERENZIALE ANTERIORE

BREMACH

Pos	Codice	Descrizione	Q.tà
5	91B0920	BEVEL GEAR (COPPIA-CONICA ANTER. 9/46)	1
5	91B0921	BEVEL GEAR (COPPIA-CONICA ANTER. 10/45)	1
45	90A9208	BELL (CAMPANA DIFFERENZIALE)	1

DIFFERENZIALE ANTERIORE

BREMACH

BREMACH

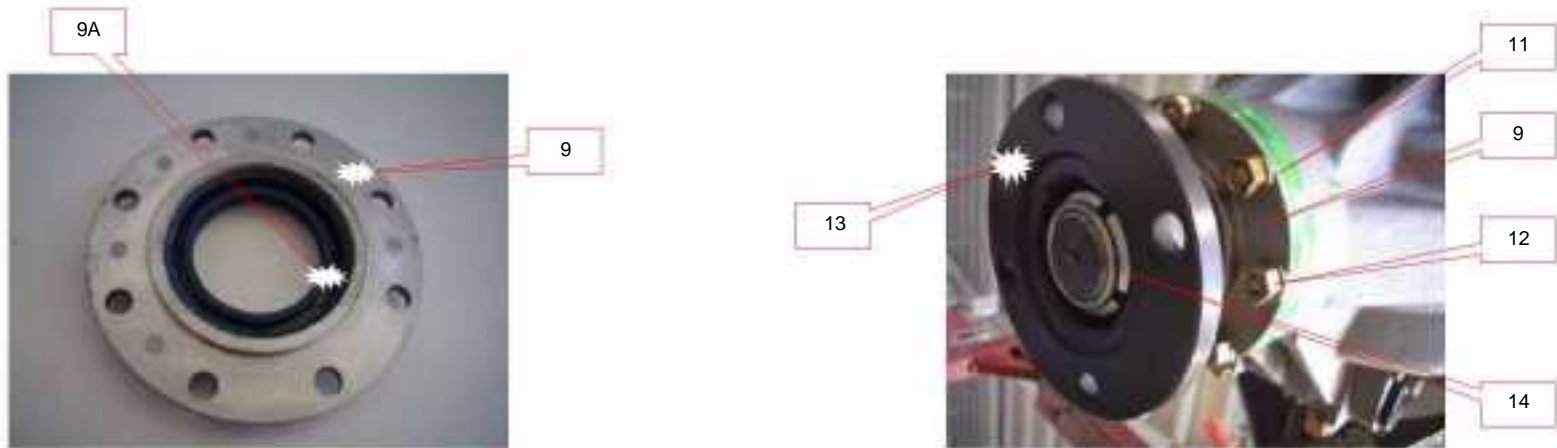

DIFFERENZIALE ANTERIORE

Pos	Codice	Descrizione	Q.tà
2	80719	STUD BOLT (PRIGIONIERO M 8)	4
3	90A2029	STUD BOLT (PRIGIONIERO STAFFA BLOCC. DIFFERENZIALE)	4
4	90A2004	COMPASS (BUSSOLA PIGNONE BLOCC. DIFFERENZIALE)	1
6	90A2015	BEARING (CUSCINETTO 33207)	2
7	90A2016	SPACER (DISTANZIALE CUSCINETTI PIGNONE)	1
8	90R1026	OR (OR 4118 (29,75X3,53))	1
9	90A2011	STATION (SEDE PREMISTOPPA DIFF.)	1
9a	90R1024	RING (ANELLO DI TEN. BASL 45X62X8)	1
11	203003	COLLAR (ROSETTA CON. EL. 8X16X1,9)	1
12	202004	NUT (DADO M8)	1
13	90R1062	FLANGE (FLANGIA PER CARDANO D. 116)	1
14	90R1025	RING NUT (GHIERA AUTOBL. M30X1,5)	3
50A	90R1020	SHIM (RASAMENTO TIPO PS 35X45X0,2)	1
50B	90R1021	SHIM (RASAMENTO TIPO PS 35X45X0,5)	1
50C	90R1032	SHIM (RASAMENTO TIPO PS 35X45X0,1)	1

DIFFERENZIALE ANTERIORE

BREMACH

BREMACH

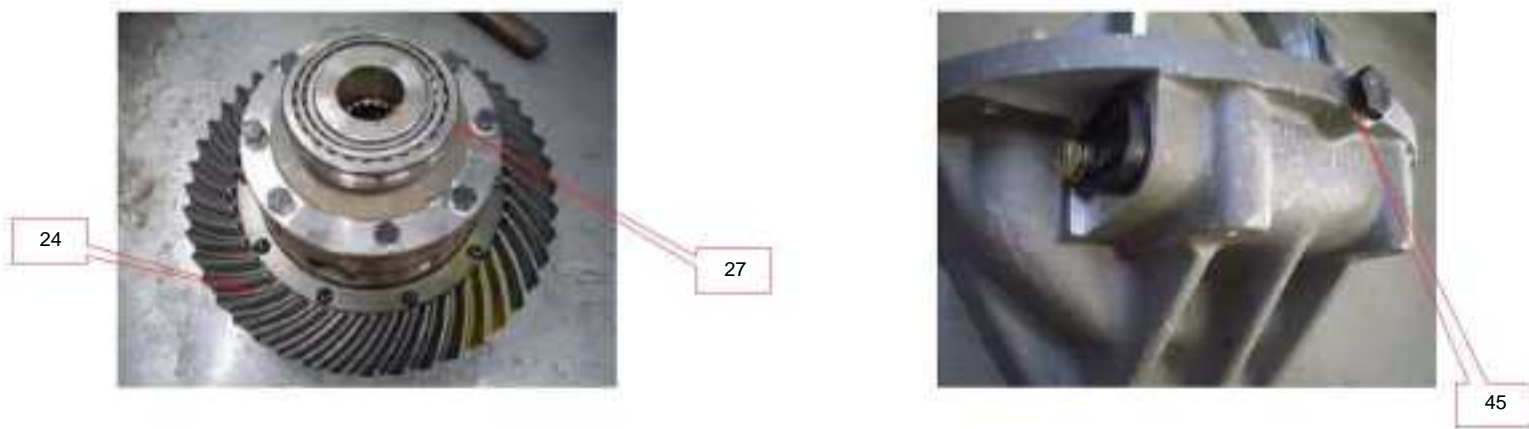
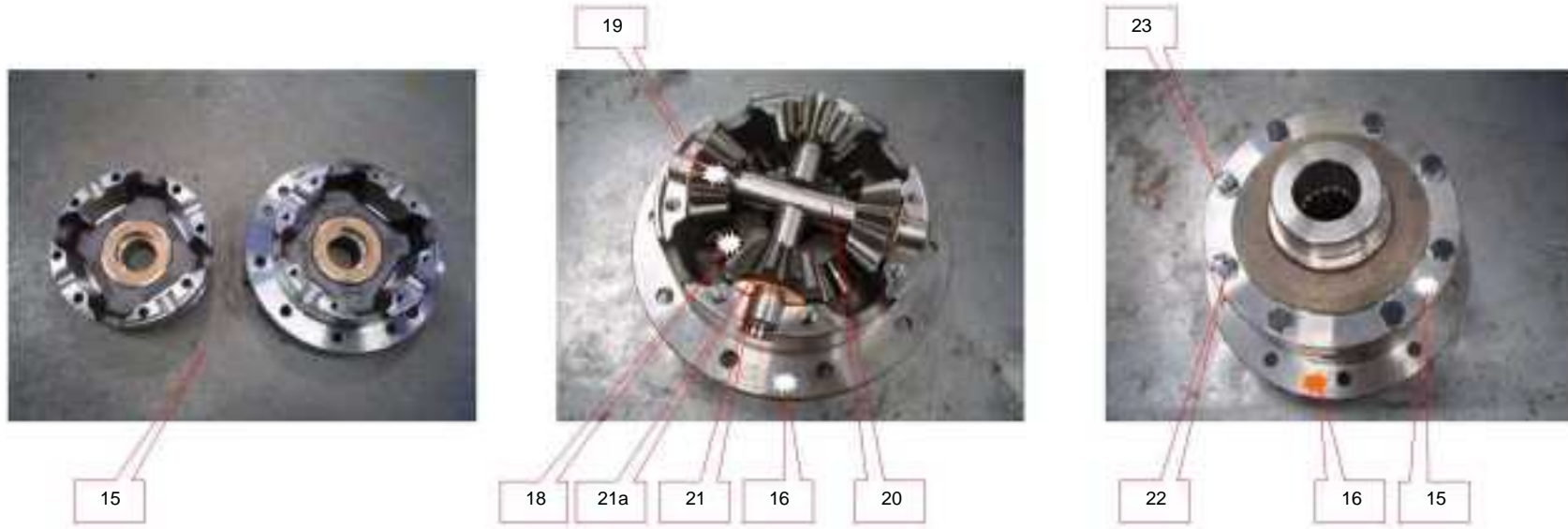

DIFFERENZIALE ANTERIORE

Pos	Codice	Descrizione	Q.tà
15	90A9205.00	BOX (SCATOLA PORTA SATELLITI 35 Q.LI)	1
15	91A9206	BOX (SCATOLA PORTA SATELLITI 60 Q.LI)	1
16	90A9200	BOX (SCATOLA PORTA SATELLITI COMPLETA 60 Q.LI)	1
16	90A9206	BOX (SCATOLA PORTA SATELLITI COMPLETA 35 Q.LI)	1
18	91A9207	PLANETARY GEARING (PLANETARIO DIFFERENZIALE 60 Q.LI)	2
18	A9017	PLANETARY GEARING (PLANETARIO DIFFERENZIALE 35 Q.LI)	2
19	A9016	SATELLITE (SATELLITE DIFFERENZIALE)	4
20	90A2035	PIVOT (PERNO PORTASATELLITI 6,0 TONN.)	2
20	A9012	PIVOT (PERNO PORTASATELLITI 3,5 TONN.)	2
21	80731	SHIM (RASAMENTO BRONZO SATELLITE)	4
21a	80733	SHIM (RASAMENTO BRONZO PLANETERIO 35 Q.LI)	2
21a	91A9208	SHIM (RASAMENTO BRONZO PLANETERIO 60 Q.LI)	2
22	201098	SCREW (VITE M8X60 10,9 UNI5737 BRUN.)	4
23	203103	WASHER (RONDELLA PIANA 8X15X1,5)	4
24	91A2004	GEAR (CORONA)	1
27	A9503	BEARING (CUSCINETTO 32012)	2
45	90A9208	BELL (CAMPANA DIFFERENZIALE)	1

DIFFERENZIALE ANTERIORE

BREMACH

BREMACH



DIFFERENZIALE ANTERIORE

Pos	Codice	Descrizione	Q.tà
24	91A2004	GEAR (CORONA)	1
25	201127	SCREW (VITE M10X30X1,25 UNI 5740 12.9)	10
26	203004	WASHER (RONDELLA D.10)	4
28	90A2013	RING NUT (GHIERA REGOLAZIONE DIFFERENZIALE)	2
29	202114	NUT (DADO M12X1,5 AUT. MB CLASSE 6S)	4
30	90A2014	PLAQUE (PIASTRINA RITEGNO GHIERA DIFFERENZIALE)	2
31	205003	SPLIT PIN (COPPIGLIA D. 3,5X45 UNI 1336A)	2
32	90A4008	PLUG (SPINA DI CENTRAGGIO)	2
33	90A2010	PLUG (SPINA DI COLLEGAMENTO)	2
43	90R1035	CAP (TAPPO IN LAMIERA D 20)	3

DIFFERENZIALE ANTERIORE

BREMACH

BREMACH

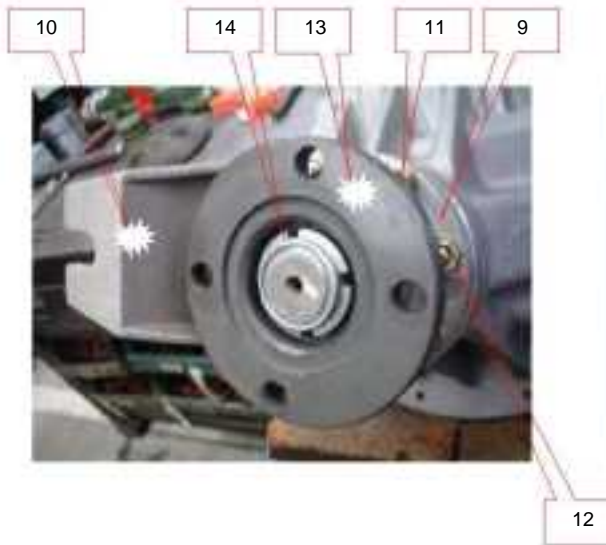
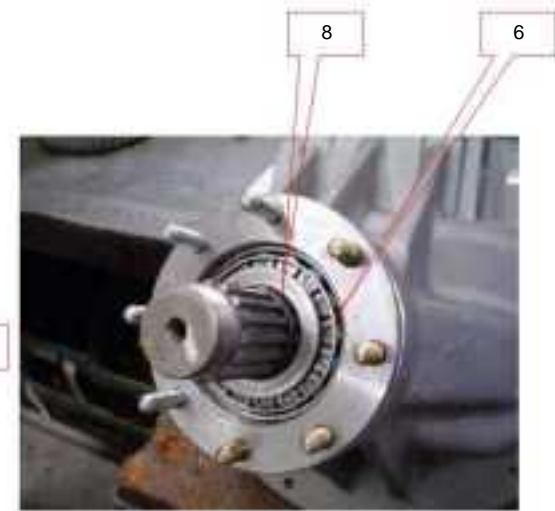

DIFFERENZIALE ANTERIORE

Pos	Codice	Descrizione	Q.tà
2	80719	STUD BOLT (PRIGIONIERO M 8)	4
3	90A2029	STUD BOLT (PRIGIONIERO STAFFA BLOCC. DIFFERENZIALE)	4
4	90A2004	COMPASS (BUSSOLA PIGNONE BLOCC. DIFFERENZIALE)	1
6	90A2015	BEARING (CUSCINETTO 33207)	2
7	90A2016	SPACER (DISTANZIALE CUSCINETTI PIGNONE)	1
8	90R1026	OR (OR 4118 (29,75X3,53))	1
9	90A2011	STATION (SEDE PREMISTOPPA DIFF.)	1
9a	90R1024	RING (ANELLO DI TEN. BASL 45X62X8)	1
10	90A2024	SUPPORT (SUPPORTO PER CAVO BLOCC. DIFFERENZIALE)	1
11	203003	COLLAR (ROSETTA CON. EL. 8X16X1,9)	1
12	202004	NUT (DADO M8)	1
13	90R1062	FLANGE (FLANGIA PER CARDANO D. 116)	1
14	90R1025	RING NUT (GHIERA AUTOBL. M30X1,5)	3
15	90A9205.00	BOX (SCATOLA PORTA SATELLITI 35 Q.LI)	1
15	91A9206	BOX (SCATOLA PORTA SATELLITI 60 Q.LI)	1
50A	90R1020	SHIM (RASAMENTO TIPO PS 35X45X0,2)	1
50B	90R1021	SHIM (RASAMENTO TIPO PS 35X45X0,5)	1
50C	90R1032	SHIM (RASAMENTO TIPO PS 35X45X0,1)	1

DIFFERENZIALE ANTERIORE

BREMACH

BREMACH

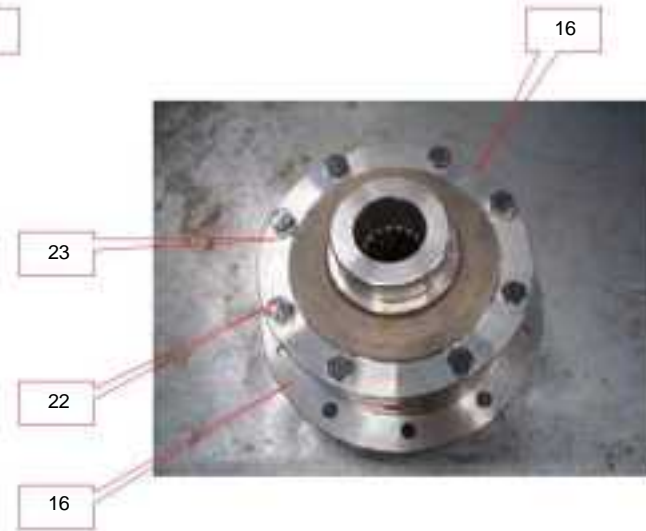

DIFFERENZIALE ANTERIORE

BREMACH

Pos	Codice	Descrizione	Q.tà
5	91B0920	BEVEL GEAR (COPPIA-CONICA ANTER. 9/46)	1
5	91B0921	BEVEL GEAR (COPPIA-CONICA ANTER. 10/45)	1
16	90A9200	BOX (SCATOLA PORTA SATELLITI COMPLETA 60 Q.LI)	1
16	90A9206	BOX (SCATOLA PORTA SATELLITI COMPLETA 35 Q.LI)	1
18	91A9207	PLANETARY GEARING (PLANETARIO DIFFERENZIALE 60 Q.LI)	2
18	A9017	PLANETARY GEARING (PLANETARIO DIFFERENZIALE 35 Q.LI)	2
19	A9016	SATELLITE (SATELLITE DIFFERENZIALE)	4
20	90A2035	PIVOT (PERNO PORTASATELLITI 6,0 TONN.)	2
20	A9012	PIVOT (PERNO PORTASATELLITI 3,5 TONN.)	2
21	80731	SHIM (RASAMENTO BRONZO SATELLITE)	4
21a	80733	SHIM (RASAMENTO BRONZO PLANETERIO 35 Q.LI)	2
21a	91A9208	SHIM (RASAMENTO BRONZO PLANETERIO 60 Q.LI)	2
22	201098	SCREW (VITE M8X60 10,9 UNI5737 BRUN.)	4
23	203103	WASHER (RONDELLA PIANA 8X15X1,5)	4
27	A9503	BEARING (CUSCINETTO 32012)	1
44	90A2022	SPRING (MOLLA DI RICHIAMO)	1
46	90A2007	LEVER (LEVA DOPPIA COMANDO BL. DIFF.)	1
47	83375	LUBRICATOR (INGRASSATORE)	1
48	A9545	SEEGER (SEEGER E 18)	1

DIFFERENZIALE ANTERIORE

BREMACH

BREMACH



DIFFERENZIALE ANTERIORE

Pos	Codice	Descrizione	Q.tà
24	91A2004	GEAR (CORONA)	1
25	201127	SCREW (VITE M10X30X1,25 UNI 5740 12.9)	10
26	203004	WASHER (RONDELLA D.10)	4
28	90A2013	RING NUT (GHIERA REGOLAZIONE DIFFERENZIALE)	2
29	202114	NUT (DADO M12X1,5 AUT. MB CLASSE 6S)	4
30	90A2014	PLAQUE (PIASTRINA RITEGNO GHIERA DIFFERENZIALE)	2
31	205003	SPLIT PIN (COPPIGLIA D. 3,5X45 UNI 1336A)	2
32	90A4008	PLUG (SPINA DI CENTRAGGIO)	2
33	90A2010	PLUG (SPINA DI COLLEGAMENTO)	2
34	90A2018	SHAFT (ALBERO FORCELLA BLOCC. DIFFERENZIALE)	1
35	90A2003	FORK (FORCELLA PER BLOCC. DIFFERENZIALE)	1
38	90A2020	PIVOT (PERNO FERMO FORCELLA)	1
39	202202	NUT (DADO M10X1,25 H=6 UNI 5589)	1
40	90A2019	SEAL (GUARNIZIONE OR 2018)	1
41	90A2021	ENGAGEMENT (INNESTO SCORR. BLOCC. DIFFERENZIALE 35 Q.LI)	1
42	A2017	THROTTLE VALVE (FARFALLA PER FORCELLA INNESTO)	4
43	90R1035	CAP (TAPPO IN LAMIERA D 20)	3

DIFFERENZIALE ANTERIORE

BREMACH

BREMACH



DIFFERENZIALE ANTERIORE

BREMACH

Pos	Codice	Descrizione	Q.tà
5	91B0920	BEVEL GEAR (COPPIA-CONICA ANTER. 9/46)	1
45	90A9208	BELL (CAMPANA DIFFERENZIALE)	1

DIFFERENZIALE ANTERIORE

BREMACH

BREMACH

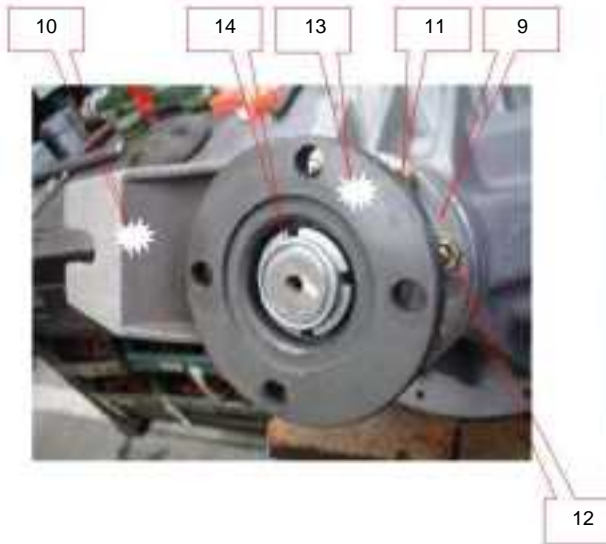
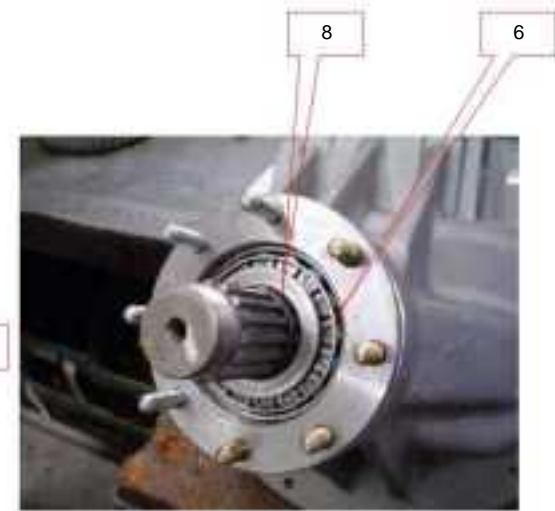
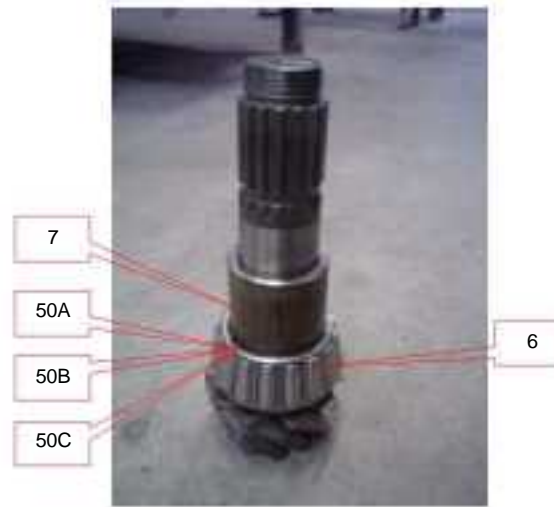

DIFFERENZIALE ANTERIORE

Pos	Codice	Descrizione	Q.tà
2	80719	STUD BOLT (PRIGIONIERO M 8)	4
3	90A2029	STUD BOLT (PRIGIONIERO STAFFA BLOCC. DIFFERENZIALE)	4
4	90A2004	COMPASS (BUSSOLA PIGNONE BLOCC. DIFFERENZIALE)	1
6	90A2015	BEARING (CUSCINETTO 33207)	2
7	90A2016	SPACER (DISTANZIALE CUSCINETTI PIGNONE)	1
8	90R1026	OR (OR 4118 (29,75X3,53))	1
9	90A2011	STATION (SEDE PREMISTOPPA DIFF.)	1
9a	90R1024	RING (ANELLO DI TEN. BASL 45X62X8)	1
10	90A2024	SUPPORT (SUPPORTO PER CAVO BLOCC. DIFFERENZIALE)	1
11	203003	COLLAR (ROSETTA CON. EL. 8X16X1,9)	1
12	202004	NUT (DADO M8)	1
13	90R1062	FLANGE (FLANGIA PER CARDANO D. 116)	1
14	90R1025	RING NUT (GHIERA AUTOBL. M30X1,5)	3
15	90A9205.00	BOX (SCATOLA PORTA SATELLITI 35 Q.LI)	1
15	91A9206	BOX (SCATOLA PORTA SATELLITI 60 Q.LI)	1
50A	90R1020	SHIM (RASAMENTO TIPO PS 35X45X0,2)	1
50B	90R1021	SHIM (RASAMENTO TIPO PS 35X45X0,5)	1
50C	90R1032	SHIM (RASAMENTO TIPO PS 35X45X0,1)	1

DIFFERENZIALE ANTERIORE

BREMACH

BREMACH

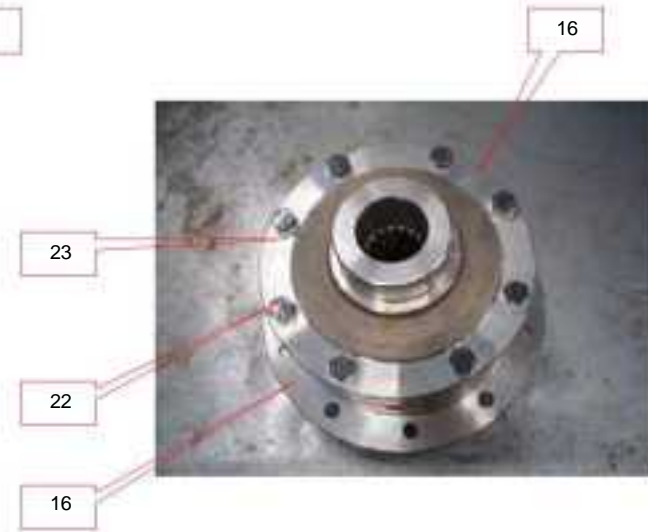

DIFFERENZIALE ANTERIORE

Pos	Codice	Descrizione	Q.tà
5	90B0920	BEVEL GEAR (COPPIA-CONICA ANTERIORE)	1
16	90A9200	BOX (SCATOLA PORTA SATELLITI COMPLETA 60 Q.LI)	1
16	90A9206	BOX (SCATOLA PORTA SATELLITI COMPLETA 35 Q.LI)	1
18	91A9207	PLANETARY GEARING (PLANETARIO DIFFERENZIALE 60 Q.LI)	2
18	A9017	PLANETARY GEARING (PLANETARIO DIFFERENZIALE 35 Q.LI)	2
19	A9016	SATELLITE (SATELLITE DIFFERENZIALE)	4
20	90A2035	PIVOT (PERNO PORTASATELLITI 6,0 TONN.)	2
20	A9012	PIVOT (PERNO PORTASATELLITI 3,5 TONN.)	2
21	80731	SHIM (RASAMENTO BRONZO SATELLITE)	4
21a	80733	SHIM (RASAMENTO BRONZO PLANETERIO 35 Q.LI)	2
21a	91A9208	SHIM (RASAMENTO BRONZO PLANETERIO 60 Q.LI)	2
22	201098	SCREW (VITE M8X60 10,9 UNI5737 BRUN.)	4
23	203103	WASHER (RONDELLA PIANA 8X15X1,5)	4
27	A9503	BEARING (CUSCINETTO 32012)	2
44	90A2022	SPRING (MOLLA DI RICHIAMO)	1
46	90A2007	LEVER (LEVA DOPPIA COMANDO BL. DIFF.)	1
47	83375	LUBRICATOR (INGRASSATORE)	1
48	A9545	SEEGER (SEEGER E 18)	1

DIFFERENZIALE ANTERIORE

BREMACH

BREMACH



DIFFERENZIALE ANTERIORE

Pos	Codice	Descrizione	Q.tà
24	91A2004	GEAR (CORONA)	1
25	201127	SCREW (VITE M10X30X1,25 UNI 5740 12.9)	10
26	203004	WASHER (RONDELLA D.10)	4
28	90A2013	RING NUT (GHIERA REGOLAZIONE DIFFERENZIALE)	2
29	202114	NUT (DADO M12X1,5 AUT. MB CLASSE 6S)	4
30	90A2014	PLAQUE (PIASTRINA RITEGNO GHIERA DIFFERENZIALE)	2
31	205003	SPLIT PIN (COPPIGLIA D. 3,5X45 UNI 1336A)	2
32	90A4008	PLUG (SPINA DI CENTRAGGIO)	2
33	90A2010	PLUG (SPINA DI COLLEGAMENTO)	2
34	90A2018	SHAFT (ALBERO FORCELLA BLOCC. DIFFERENZIALE)	1
35	90A2003	FORK (FORCELLA PER BLOCC. DIFFERENZIALE)	1
38	90A2020	PIVOT (PERNO FERMO FORCELLA)	1
39	202202	NUT (DADO M10X1,25 H=6 UNI 5589)	1
40	90A2019	SEAL (GUARNIZIONE OR 2018)	1
41	90A2021	ENGAGEMENT (INNESTO SCORR. BLOCC. DIFFERENZIALE 35 Q.LI)	1
42	A2017	THROTTLE VALVE (FARFALLA PER FORCELLA INNESTO)	4
43	90R1035	CAP (TAPPO IN LAMIERA D 20)	3

DIFFERENZIALE ANTERIORE

BREMACH

BREMACH



DIFFERENZIALE ANTERIORE

BREMACH

Pos	Codice	Descrizione	Q.tà
5	90B0920	BEVEL GEAR (COPPIA-CONICA ANTERIORE)	1
45	90A9208	BELL (CAMPANA DIFFERENZIALE)	1

DIFFERENZIALE ANTERIORE

BREMACH

BREMACH



DIFFERENZIALE POSTERIORE

BREMACH

Pos	Codice	Descrizione	Q.tà
5	91B0920	BEVEL GEAR (COPPIA-CONICA ANTER. 9/46)	1
5	91B0921	BEVEL GEAR (COPPIA-CONICA ANTER. 10/45)	1
45	90A9208	BELL (CAMPANA DIFFERENZIALE)	1

DIFFERENZIALE POSTERIORE

BREMACH

BREMACH

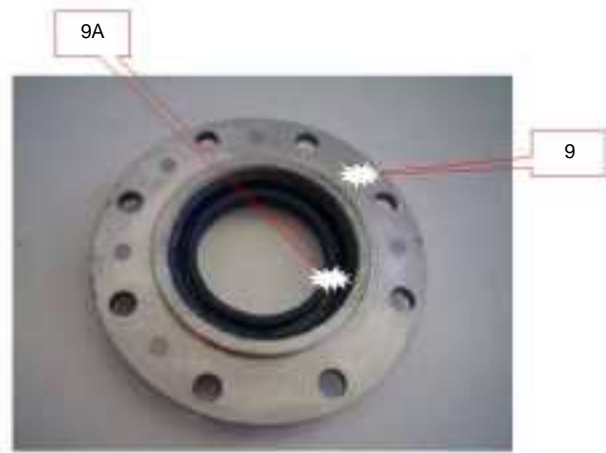
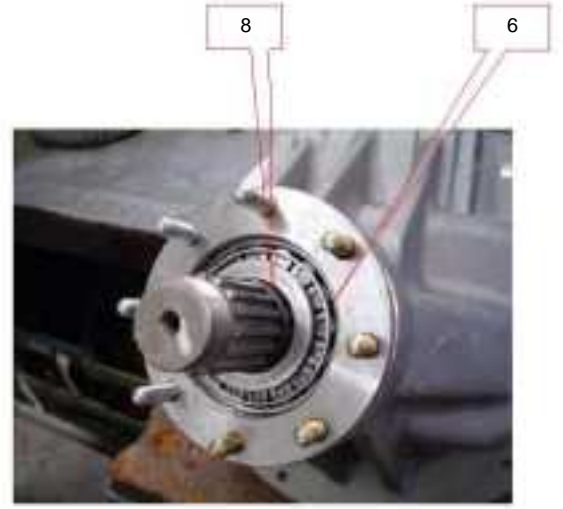

DIFFERENZIALE POSTERIORE

Pos	Codice	Descrizione	Q.tà
2	80719	STUD BOLT (PRIGIONIERO M 8)	4
3	90A2029	STUD BOLT (PRIGIONIERO STAFFA BLOCC. DIFFERENZIALE)	4
4	90A2004	COMPASS (BUSSOLA PIGNONE BLOCC. DIFFERENZIALE)	1
6	90A2015	BEARING (CUSCINETTO 33207)	2
7	90A2016	SPACER (DISTANZIALE CUSCINETTI PIGNONE)	1
8	90R1026	OR (OR 4118 (29,75X3,53))	1
9	90A2011	STATION (SEDE PREMISTOPPA DIFF.)	1
9a	90R1024	RING (ANELLO DI TEN. BASL 45X62X8)	1
11	203003	COLLAR (ROSETTA CON. EL. 8X16X1,9)	1
12	202004	NUT (DADO M8)	1
13	90R1062	FLANGE (FLANGIA PER CARDANO D. 116)	1
14	90R1025	RING NUT (GHIERA AUTOBL. M30X1,5)	3
50A	90R1020	SHIM (RASAMENTO TIPO PS 35X45X0,2)	1
50B	90R1021	SHIM (RASAMENTO TIPO PS 35X45X0,5)	1
50C	90R1032	SHIM (RASAMENTO TIPO PS 35X45X0,1)	1

DIFFERENZIALE POSTERIORE

BREMACH

BREMACH

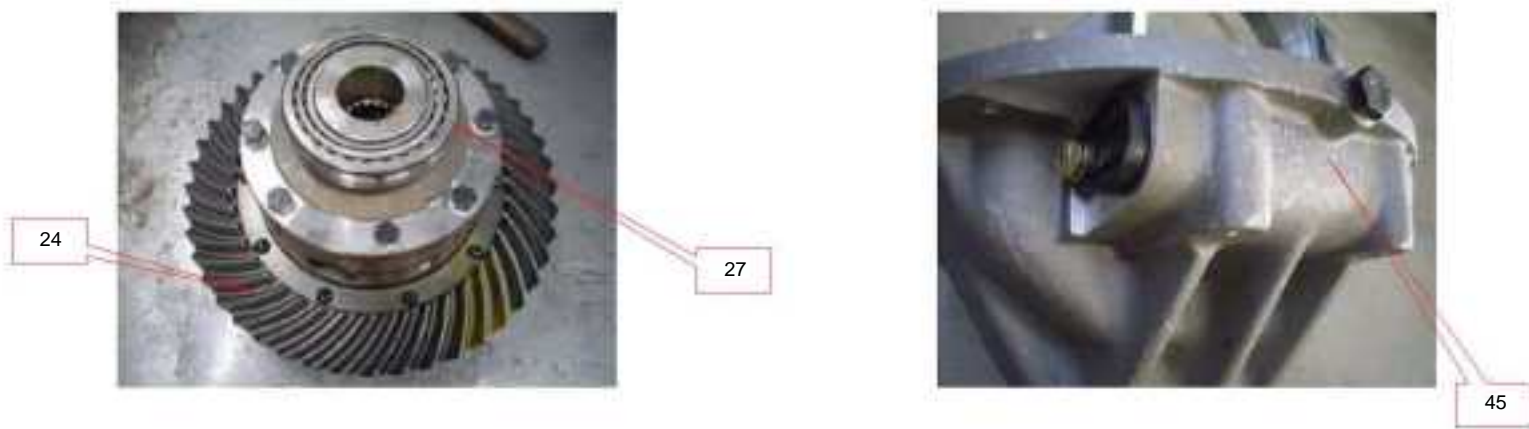
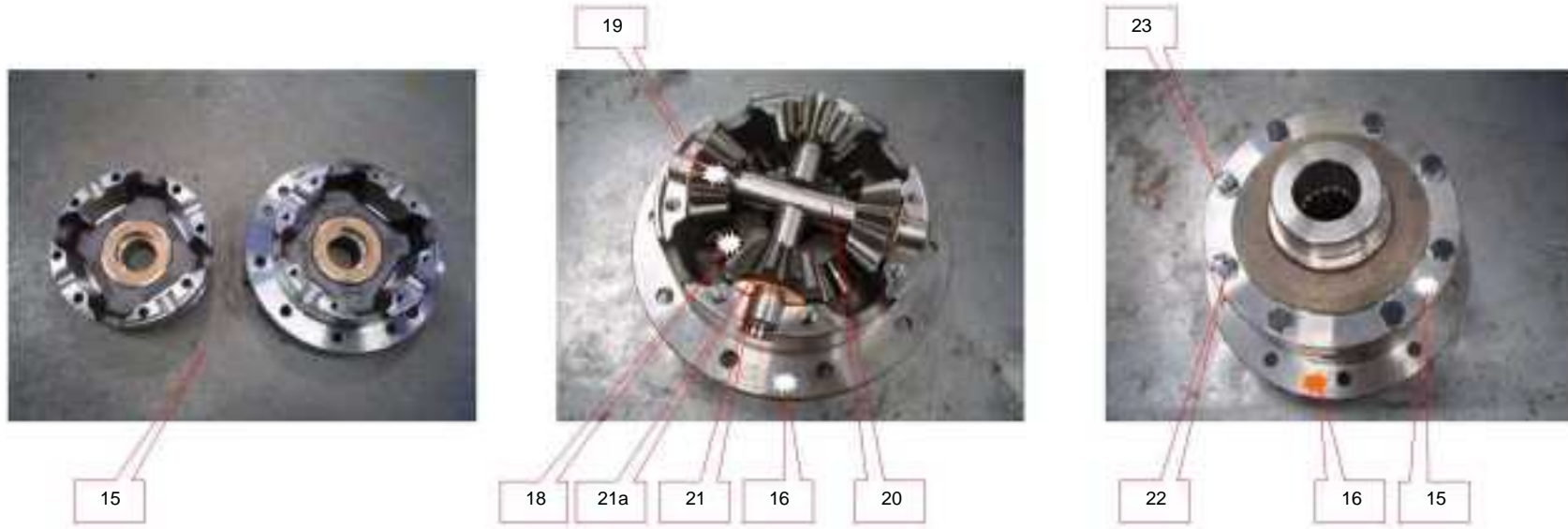

DIFFERENZIALE POSTERIORE

Pos	Codice	Descrizione	Q.tà
15	90A9205.00	BOX (SCATOLA PORTA SATELLITI 35 Q.LI)	1
15	91A9206	BOX (SCATOLA PORTA SATELLITI 60 Q.LI)	1
16	90A9200	BOX (SCATOLA PORTA SATELLITI COMPLETA 60 Q.LI)	1
16	90A9206	BOX (SCATOLA PORTA SATELLITI COMPLETA 35 Q.LI)	1
18	91A9207	PLANETARY GEARING (PLANETARIO DIFFERENZIALE 60 Q.LI)	2
18	A9017	PLANETARY GEARING (PLANETARIO DIFFERENZIALE 35 Q.LI)	2
19	A9016	SATELLITE (SATELLITE DIFFERENZIALE)	4
20	90A2035	PIVOT (PERNO PORTASATELLITI 6,0 TONN.)	2
20	A9012	PIVOT (PERNO PORTASATELLITI 3,5 TONN.)	2
21	80731	SHIM (RASAMENTO BRONZO SATELLITE)	4
21a	80733	SHIM (RASAMENTO BRONZO PLANETERIO 35 Q.LI)	2
21a	91A9208	SHIM (RASAMENTO BRONZO PLANETERIO 60 Q.LI)	2
22	201098	SCREW (VITE M8X60 10,9 UNI5737 BRUN.)	4
23	203103	WASHER (RONDELLA PIANA 8X15X1,5)	4
24	91A2004	GEAR (CORONA)	1
27	A9503	BEARING (CUSCINETTO 32012)	2
45	90A9208	BELL (CAMPANA DIFFERENZIALE)	1

DIFFERENZIALE POSTERIORE

BREMACH

BREMACH



DIFFERENZIALE POSTERIORE

Pos	Codice	Descrizione	Q.tà
24	91A2004	GEAR (CORONA)	1
25	201127	SCREW (VITE M10X30X1,25 UNI 5740 12.9)	10
26	203004	WASHER (RONDELLA D.10)	4
28	90A2013	RING NUT (GHIERA REGOLAZIONE DIFFERENZIALE)	2
29	202114	NUT (DADO M12X1,5 AUT. MB CLASSE 6S)	4
30	90A2014	PLAQUE (PIASTRINA RITEGNO GHIERA DIFFERENZIALE)	2
31	205003	SPLIT PIN (COPPIGLIA D. 3,5X45 UNI 1336A)	2
32	90A4008	PLUG (SPINA DI CENTRAGGIO)	2
33	90A2010	PLUG (SPINA DI COLLEGAMENTO)	2
43	90R1035	CAP (TAPPO IN LAMIERA D 20)	3

DIFFERENZIALE POSTERIORE

BREMACH

BREMACH



DIFFERENZIALE POSTERIORE

BREMACH

Pos	Codice	Descrizione	Q.tà
5	91B0920	BEVEL GEAR (COPPIA-CONICA ANTER. 9/46)	1
5	91B0921	BEVEL GEAR (COPPIA-CONICA ANTER. 10/45)	1
45	90A9208	BELL (CAMPANA DIFFERENZIALE)	1

DIFFERENZIALE POSTERIORE

BREMACH

BREMACH

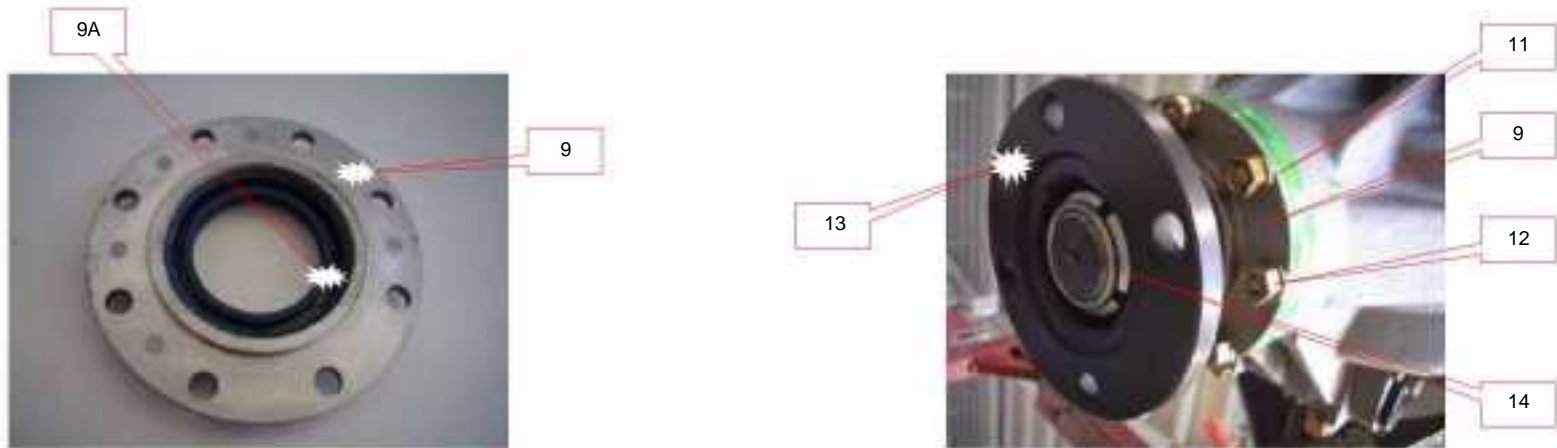

DIFFERENZIALE POSTERIORE

Pos	Codice	Descrizione	Q.tà
2	80719	STUD BOLT (PRIGIONIERO M 8)	4
3	90A2029	STUD BOLT (PRIGIONIERO STAFFA BLOCC. DIFFERENZIALE)	4
4	90A2004	COMPASS (BUSSOLA PIGNONE BLOCC. DIFFERENZIALE)	1
6	90A2015	BEARING (CUSCINETTO 33207)	2
7	90A2016	SPACER (DISTANZIALE CUSCINETTI PIGNONE)	1
8	90R1026	OR (OR 4118 (29,75X3,53))	1
9	90A2011	STATION (SEDE PREMISTOPPA DIFF.)	1
9a	90R1024	RING (ANELLO DI TEN. BASL 45X62X8)	1
11	203003	COLLAR (ROSETTA CON. EL. 8X16X1,9)	1
12	202004	NUT (DADO M8)	1
13	90R1062	FLANGE (FLANGIA PER CARDANO D. 116)	1
14	90R1025	RING NUT (GHIERA AUTOBL. M30X1,5)	3
50A	90R1020	SHIM (RASAMENTO TIPO PS 35X45X0,2)	1
50B	90R1021	SHIM (RASAMENTO TIPO PS 35X45X0,5)	1
50C	90R1032	SHIM (RASAMENTO TIPO PS 35X45X0,1)	1

DIFFERENZIALE POSTERIORE

BREMACH

BREMACH

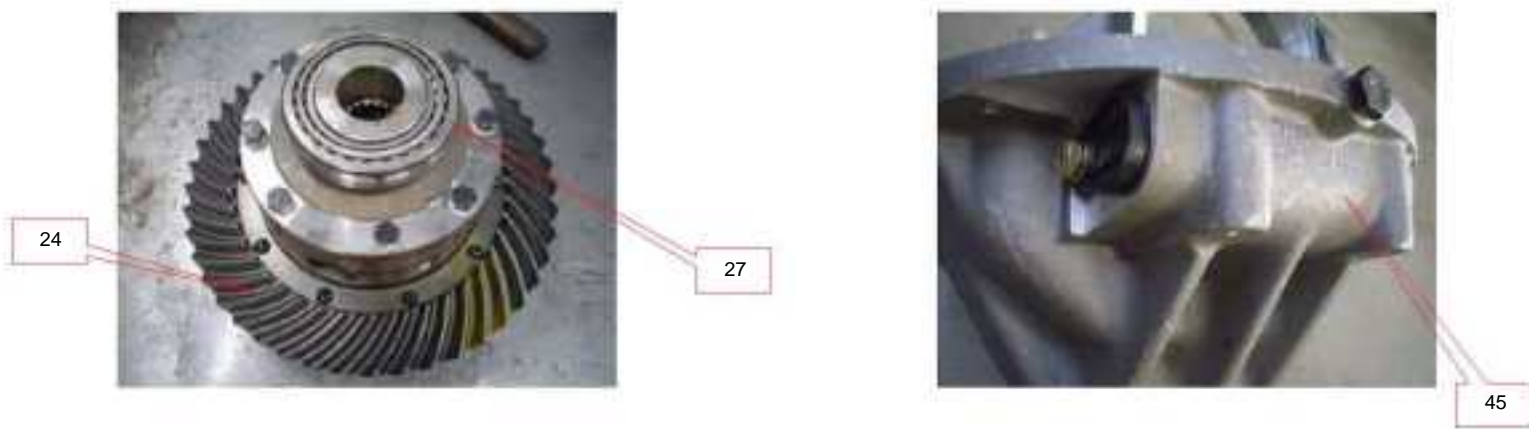
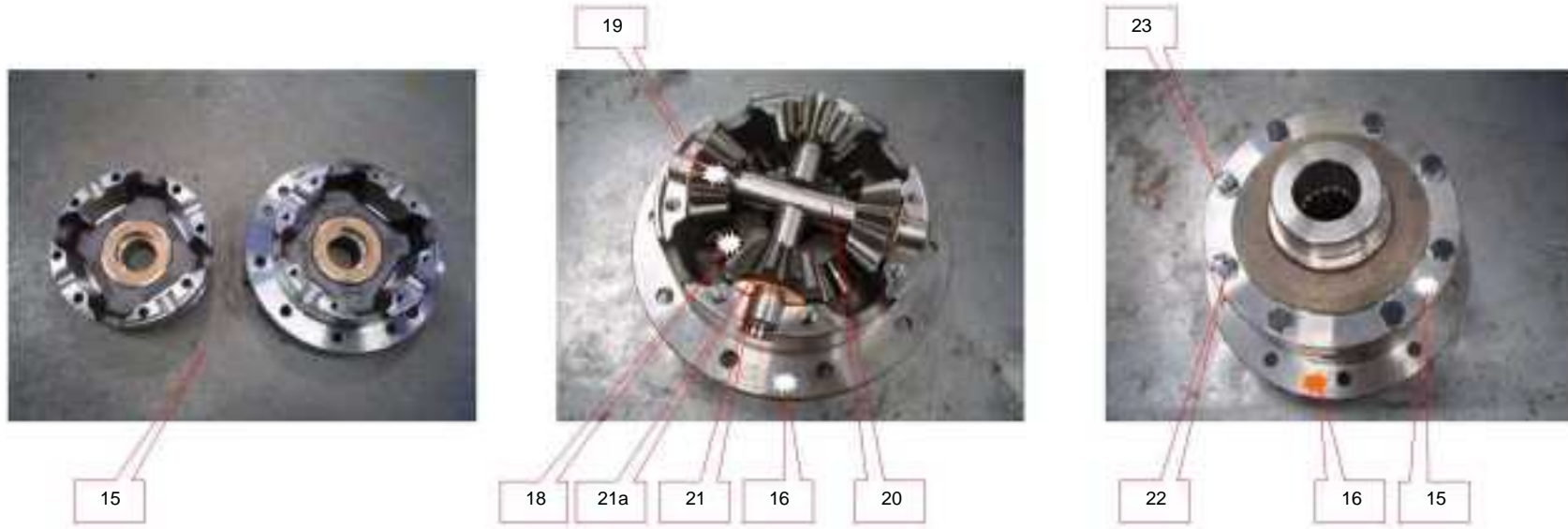

DIFFERENZIALE POSTERIORE

Pos	Codice	Descrizione	Q.tà
15	90A9205.00	BOX (SCATOLA PORTA SATELLITI 35 Q.LI)	1
15	91A9206	BOX (SCATOLA PORTA SATELLITI 60 Q.LI)	1
16	90A9200	BOX (SCATOLA PORTA SATELLITI COMPLETA 60 Q.LI)	1
16	90A9206	BOX (SCATOLA PORTA SATELLITI COMPLETA 35 Q.LI)	1
18	91A9207	PLANETARY GEARING (PLANETARIO DIFFERENZIALE 60 Q.LI)	2
18	A9017	PLANETARY GEARING (PLANETARIO DIFFERENZIALE 35 Q.LI)	2
19	A9016	SATELLITE (SATELLITE DIFFERENZIALE)	4
20	90A2035	PIVOT (PERNO PORTASATELLITI 6,0 TONN.)	2
20	A9012	PIVOT (PERNO PORTASATELLITI 3,5 TONN.)	2
21	80731	SHIM (RASAMENTO BRONZO SATELLITE)	4
21a	80733	SHIM (RASAMENTO BRONZO PLANETERIO 35 Q.LI)	2
21a	91A9208	SHIM (RASAMENTO BRONZO PLANETERIO 60 Q.LI)	2
22	201098	SCREW (VITE M8X60 10,9 UNI5737 BRUN.)	4
23	203103	WASHER (RONDELLA PIANA 8X15X1,5)	4
24	91A2004	GEAR (CORONA)	1
27	A9503	BEARING (CUSCINETTO 32012)	2
45	90A9208	BELL (CAMPANA DIFFERENZIALE)	1

DIFFERENZIALE POSTERIORE

BREMACH

BREMACH



DIFFERENZIALE POSTERIORE

Pos	Codice	Descrizione	Q.tà
24	91A2004	GEAR (CORONA)	1
25	201127	SCREW (VITE M10X30X1,25 UNI 5740 12.9)	10
26	203004	WASHER (RONDELLA D.10)	4
28	90A2013	RING NUT (GHIERA REGOLAZIONE DIFFERENZIALE)	2
29	202114	NUT (DADO M12X1,5 AUT. MB CLASSE 6S)	4
30	90A2014	PLAQUE (PIASTRINA RITEGNO GHIERA DIFFERENZIALE)	2
31	205003	SPLIT PIN (COPPIGLIA D. 3,5X45 UNI 1336A)	2
32	90A4008	PLUG (SPINA DI CENTRAGGIO)	2
33	90A2010	PLUG (SPINA DI COLLEGAMENTO)	2
43	90R1035	CAP (TAPPO IN LAMIERA D 20)	3

DIFFERENZIALE POSTERIORE

BREMACH

BREMACH



DIFFERENZIALE POSTERIORE

BREMACH

Pos	Codice	Descrizione	Q.tà
5	91B0920	BEVEL GEAR (COPPIA-CONICA ANTER. 9/46)	1
5	91B0921	BEVEL GEAR (COPPIA-CONICA ANTER. 10/45)	1
45	90A9208	BELL (CAMPANA DIFFERENZIALE)	1

DIFFERENZIALE POSTERIORE

BREMACH

BREMACH

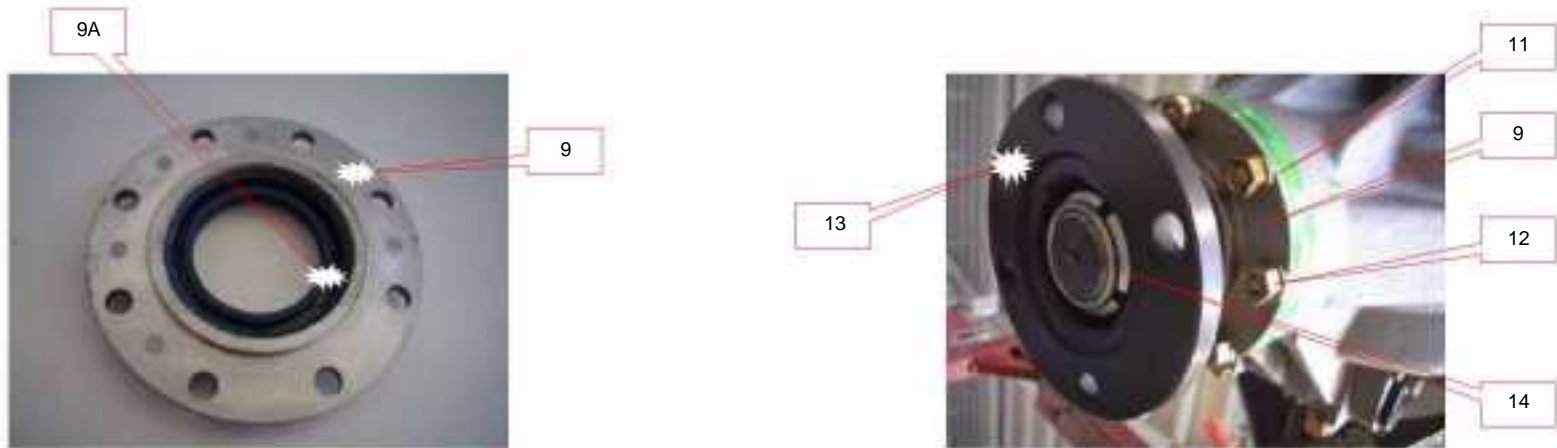

DIFFERENZIALE POSTERIORE

Pos	Codice	Descrizione	Q.tà
2	80719	STUD BOLT (PRIGIONIERO M 8)	4
3	90A2029	STUD BOLT (PRIGIONIERO STAFFA BLOCC. DIFFERENZIALE)	4
4	90A2004	COMPASS (BUSSOLA PIGNONE BLOCC. DIFFERENZIALE)	1
6	90A2015	BEARING (CUSCINETTO 33207)	2
7	90A2016	SPACER (DISTANZIALE CUSCINETTI PIGNONE)	1
8	90R1026	OR (OR 4118 (29,75X3,53))	1
9	90A2011	STATION (SEDE PREMISTOPPA DIFF.)	1
9a	90R1024	RING (ANELLO DI TEN. BASL 45X62X8)	1
11	203003	COLLAR (ROSETTA CON. EL. 8X16X1,9)	1
12	202004	NUT (DADO M8)	1
13	90R1062	FLANGE (FLANGIA PER CARDANO D. 116)	1
14	90R1025	RING NUT (GHIERA AUTOBL. M30X1,5)	3
50A	90R1020	SHIM (RASAMENTO TIPO PS 35X45X0,2)	1
50B	90R1021	SHIM (RASAMENTO TIPO PS 35X45X0,5)	1
50C	90R1032	SHIM (RASAMENTO TIPO PS 35X45X0,1)	1

DIFFERENZIALE POSTERIORE

BREMACH

BREMACH

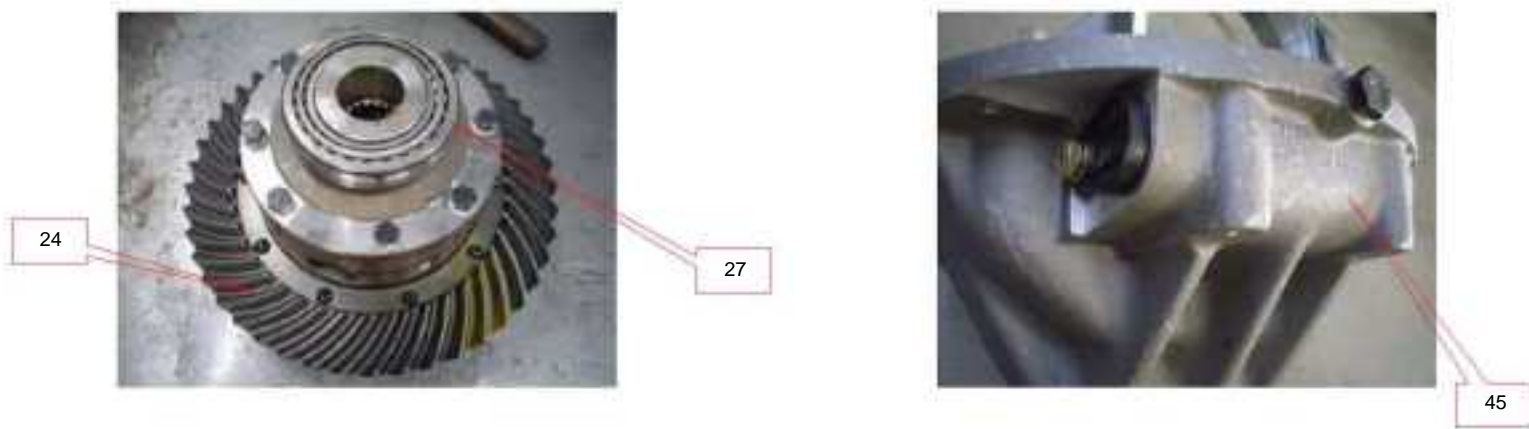
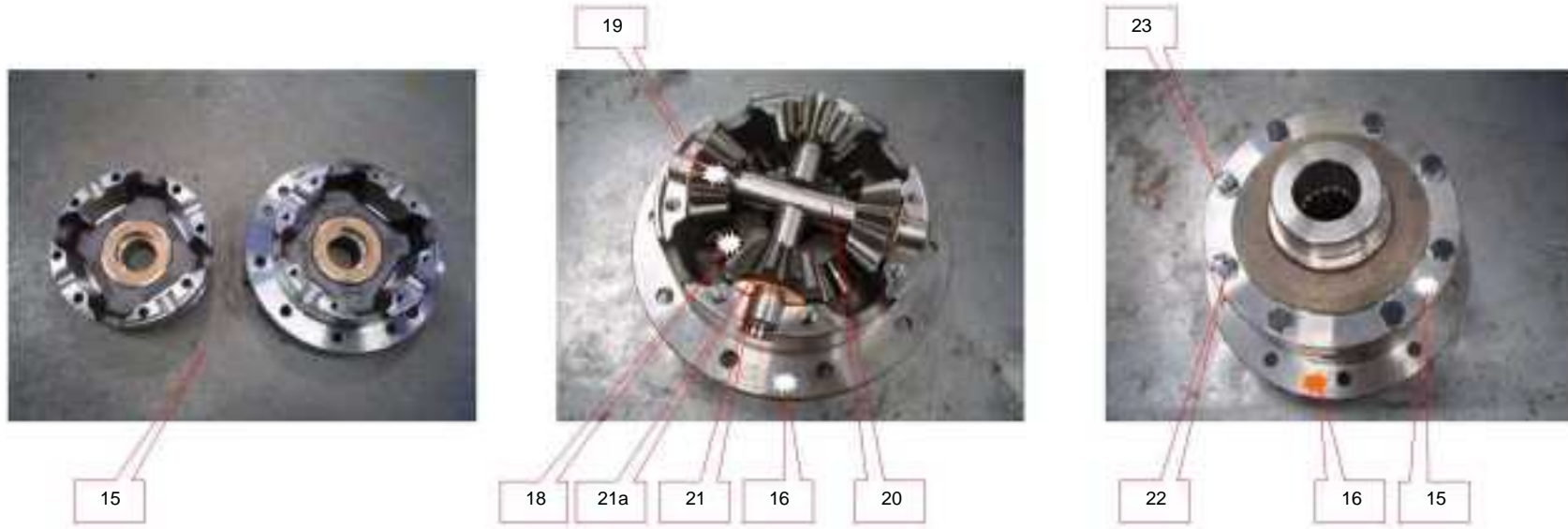

DIFFERENZIALE POSTERIORE

Pos	Codice	Descrizione	Q.tà
15	90A9205.00	BOX (SCATOLA PORTA SATELLITI 35 Q.LI)	1
15	91A9206	BOX (SCATOLA PORTA SATELLITI 60 Q.LI)	1
16	90A9200	BOX (SCATOLA PORTA SATELLITI COMPLETA 60 Q.LI)	1
16	90A9206	BOX (SCATOLA PORTA SATELLITI COMPLETA 35 Q.LI)	1
18	91A9207	PLANETARY GEARING (PLANETARIO DIFFERENZIALE 60 Q.LI)	2
18	A9017	PLANETARY GEARING (PLANETARIO DIFFERENZIALE 35 Q.LI)	2
19	A9016	SATELLITE (SATELLITE DIFFERENZIALE)	4
20	90A2035	PIVOT (PERNO PORTASATELLITI 6,0 TONN.)	2
20	A9012	PIVOT (PERNO PORTASATELLITI 3,5 TONN.)	2
21	80731	SHIM (RASAMENTO BRONZO SATELLITE)	4
21a	80733	SHIM (RASAMENTO BRONZO PLANETERIO 35 Q.LI)	2
21a	91A9208	SHIM (RASAMENTO BRONZO PLANETERIO 60 Q.LI)	2
22	201098	SCREW (VITE M8X60 10,9 UNI5737 BRUN.)	4
23	203103	WASHER (RONDELLA PIANA 8X15X1,5)	4
24	91A2004	GEAR (CORONA)	1
27	A9503	BEARING (CUSCINETTO 32012)	2
45	90A9208	BELL (CAMPANA DIFFERENZIALE)	1

DIFFERENZIALE POSTERIORE

BREMACH

BREMACH



DIFFERENZIALE POSTERIORE

Pos	Codice	Descrizione	Q.tà
24	91A2004	GEAR (CORONA)	1
25	201127	SCREW (VITE M10X30X1,25 UNI 5740 12.9)	10
26	203004	WASHER (RONDELLA D.10)	4
28	90A2013	RING NUT (GHIERA REGOLAZIONE DIFFERENZIALE)	2
29	202114	NUT (DADO M12X1,5 AUT. MB CLASSE 6S)	4
30	90A2014	PLAQUE (PIASTRINA RITEGNO GHIERA DIFFERENZIALE)	2
31	205003	SPLIT PIN (COPPIGLIA D. 3,5X45 UNI 1336A)	2
32	90A4008	PLUG (SPINA DI CENTRAGGIO)	2
33	90A2010	PLUG (SPINA DI COLLEGAMENTO)	2
43	90R1035	CAP (TAPPO IN LAMIERA D 20)	3

DIFFERENZIALE POSTERIORE

BREMACH

BREMACH



DIFFERENZIALE POSTERIORE

BREMACH

Pos	Codice	Descrizione	Q.tà
5	91B0920	BEVEL GEAR (COPPIA-CONICA ANTER. 9/46)	1
5	91B0921	BEVEL GEAR (COPPIA-CONICA ANTER. 10/45)	1
45	90A9208	BELL (CAMPANA DIFFERENZIALE)	1

DIFFERENZIALE POSTERIORE

BREMACH

BREMACH

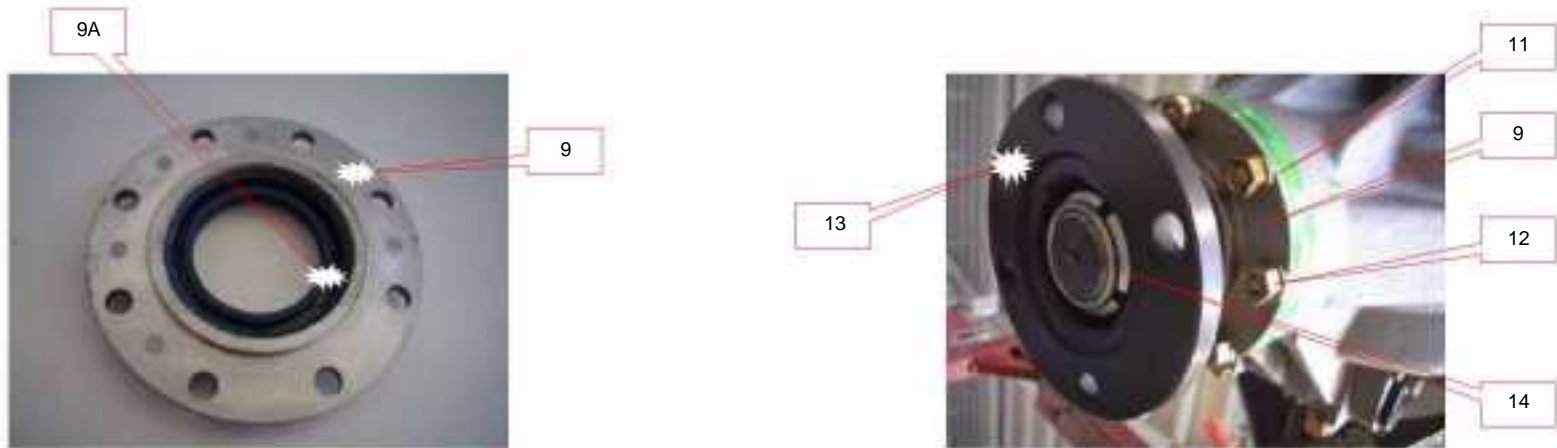

DIFFERENZIALE POSTERIORE

Pos	Codice	Descrizione	Q.tà
2	80719	STUD BOLT (PRIGIONIERO M 8)	4
3	90A2029	STUD BOLT (PRIGIONIERO STAFFA BLOCC. DIFFERENZIALE)	4
4	90A2004	COMPASS (BUSSOLA PIGNONE BLOCC. DIFFERENZIALE)	1
6	90A2015	BEARING (CUSCINETTO 33207)	2
7	90A2016	SPACER (DISTANZIALE CUSCINETTI PIGNONE)	1
8	90R1026	OR (OR 4118 (29,75X3,53))	1
9	90A2011	STATION (SEDE PREMISTOPPA DIFF.)	1
9a	90R1024	RING (ANELLO DI TEN. BASL 45X62X8)	1
11	203003	COLLAR (ROSETTA CON. EL. 8X16X1,9)	1
12	202004	NUT (DADO M8)	1
13	90R1062	FLANGE (FLANGIA PER CARDANO D. 116)	1
14	90R1025	RING NUT (GHIERA AUTOBL. M30X1,5)	3
50A	90R1020	SHIM (RASAMENTO TIPO PS 35X45X0,2)	1
50B	90R1021	SHIM (RASAMENTO TIPO PS 35X45X0,5)	1
50C	90R1032	SHIM (RASAMENTO TIPO PS 35X45X0,1)	1

DIFFERENZIALE POSTERIORE

BREMACH

BREMACH

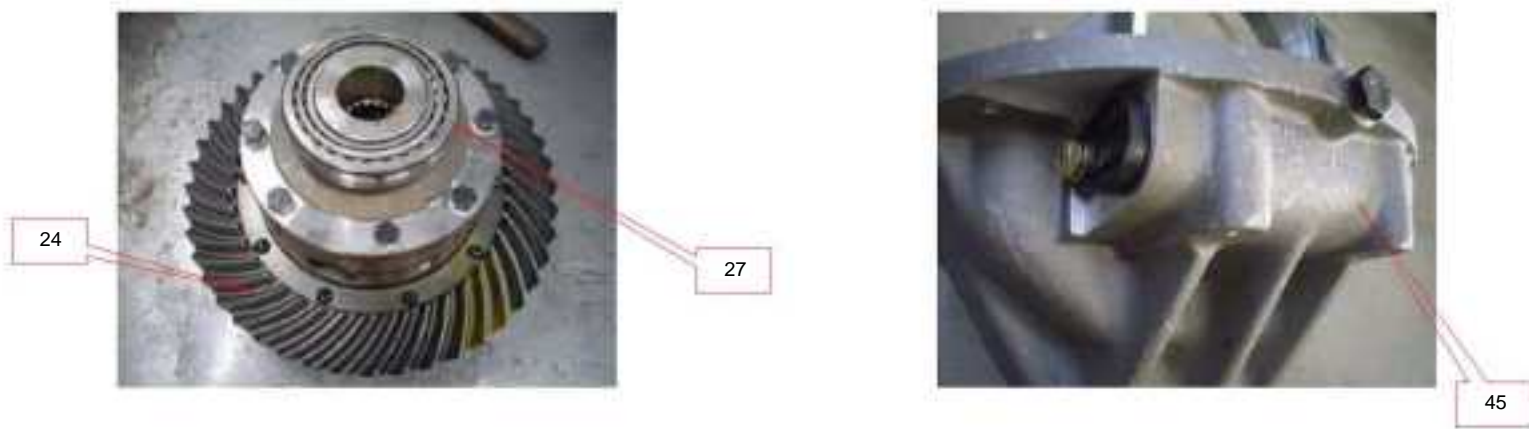
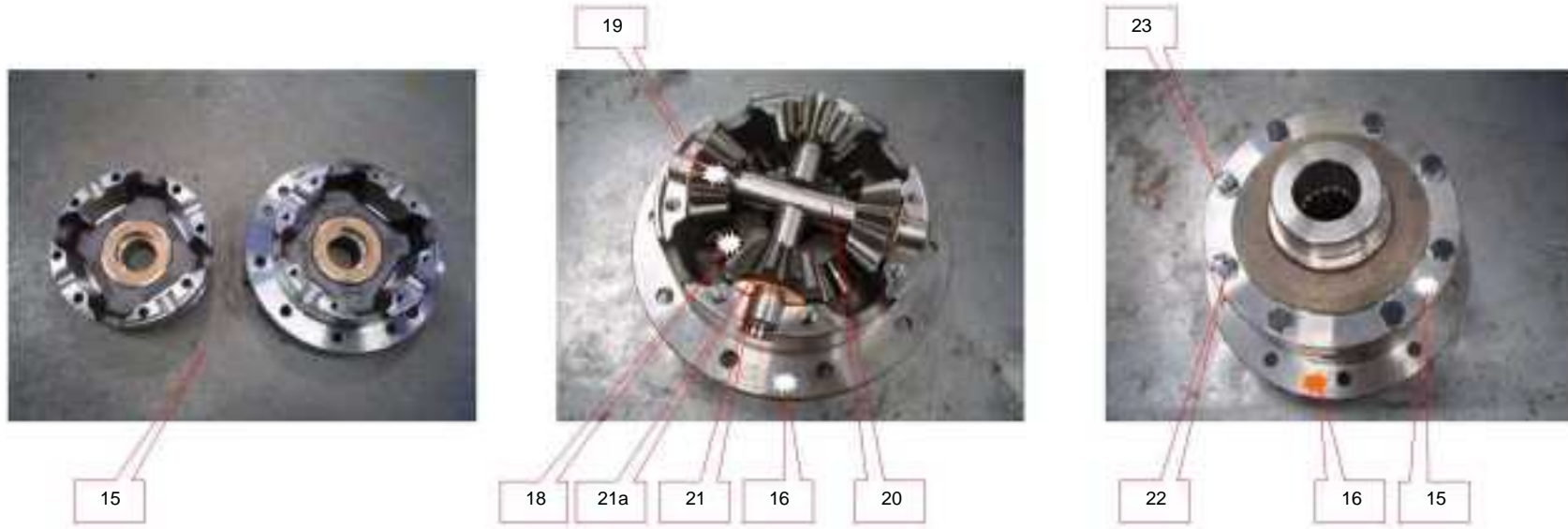

DIFFERENZIALE POSTERIORE

BREMACH

Pos	Codice	Descrizione	Q.tà
15	90A9205.00	BOX (SCATOLA PORTA SATELLITI 35 Q.LI)	1
15	91A9206	BOX (SCATOLA PORTA SATELLITI 60 Q.LI)	1
16	90A9200	BOX (SCATOLA PORTA SATELLITI COMPLETA 60 Q.LI)	1
16	90A9206	BOX (SCATOLA PORTA SATELLITI COMPLETA 35 Q.LI)	1
18	91A9207	PLANETARY GEARING (PLANETARIO DIFFERENZIALE 60 Q.LI)	2
18	A9017	PLANETARY GEARING (PLANETARIO DIFFERENZIALE 35 Q.LI)	2
19	A9016	SATELLITE (SATELLITE DIFFERENZIALE)	4
20	90A2035	PIVOT (PERNO PORTASATELLITI 6,0 TONN.)	2
20	A9012	PIVOT (PERNO PORTASATELLITI 3,5 TONN.)	2
21	80731	SHIM (RASAMENTO BRONZO SATELLITE)	4
21a	80733	SHIM (RASAMENTO BRONZO PLANETERIO 35 Q.LI)	2
21a	91A9208	SHIM (RASAMENTO BRONZO PLANETERIO 60 Q.LI)	2
22	201098	SCREW (VITE M8X60 10,9 UNI5737 BRUN.)	4
23	203103	WASHER (RONDELLA PIANA 8X15X1,5)	4
24	91A2004	GEAR (CORONA)	1
27	A9503	BEARING (CUSCINETTO 32012)	2
45	90A9208	BELL (CAMPANA DIFFERENZIALE)	1

DIFFERENZIALE POSTERIORE

BREMACH

BREMACH



DIFFERENZIALE POSTERIORE

Pos	Codice	Descrizione	Q.tà
24	91A2004	GEAR (CORONA)	1
25	201127	SCREW (VITE M10X30X1,25 UNI 5740 12.9)	10
26	203004	WASHER (RONDELLA D.10)	4
28	90A2013	RING NUT (GHIERA REGOLAZIONE DIFFERENZIALE)	2
29	202114	NUT (DADO M12X1,5 AUT. MB CLASSE 6S)	4
30	90A2014	PLAQUE (PIASTRINA RITEGNO GHIERA DIFFERENZIALE)	2
31	205003	SPLIT PIN (COPPIGLIA D. 3,5X45 UNI 1336A)	2
32	90A4008	PLUG (SPINA DI CENTRAGGIO)	2
33	90A2010	PLUG (SPINA DI COLLEGAMENTO)	2
43	90R1035	CAP (TAPPO IN LAMIERA D 20)	3

DIFFERENZIALE POSTERIORE

BREMACH

BREMACH

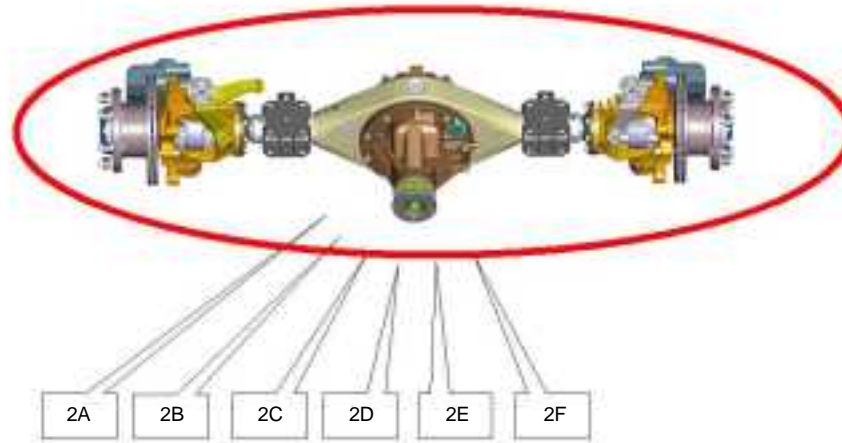

PONTE ANTERIORE

Pos	Codice	Descrizione	Q.tà
1	OSSAN00050	STRUCTURE (STRUTTURA PONTE ANTERIORE)	1
2	DIFFA00050	DIFFERENTIAL (DIFFERENZIALE ANTER. 10/45 BLN)	1
2	DIFFA00051	DIFFERENTIAL (DIFFERENZIALE ANTER. 10/45 BLS)	1
2	DIFFA00053	DIFFERENTIAL (DIFFERENZIALE ANTER. 9/46 BLN)	1
2	DIFFA00056	DIFFERENTIAL (DIFFERENZIALE ANTER. 9/46 BLS)	1
2A	PO2AB00000	AXLE (PONTE ANT. 10/45 SENZA BLOC. DIFF. 35/50 Q.LI)	1
2B	PO2AB00002	AXLE (PONTE ANT. 10/45 CON BLOC. DIFF. 35/50 Q.LI)	1
2C	PO2AB00003	AXLE (PONTE ANT. 10/45 SENZA BLOC. DIFF. 60 Q.LI)	1
2F	PO2AB00007	AXLE (PONTE ANT. 9/46 CON BLOC. DIFF. 35/50 Q.LI)	1
2D	PO2AB00008	AXLE (PONTE ANT. 10/45 CON BLOC. DIFF. 60 Q.LI)	1
2E	PO2AE00000	AXLE (PONTE ANT. 9/46 SENZA BLOC. DIFF. 35/50 Q.LI)	1

PONTE ANTERIORE

BREMACH

BREMACH

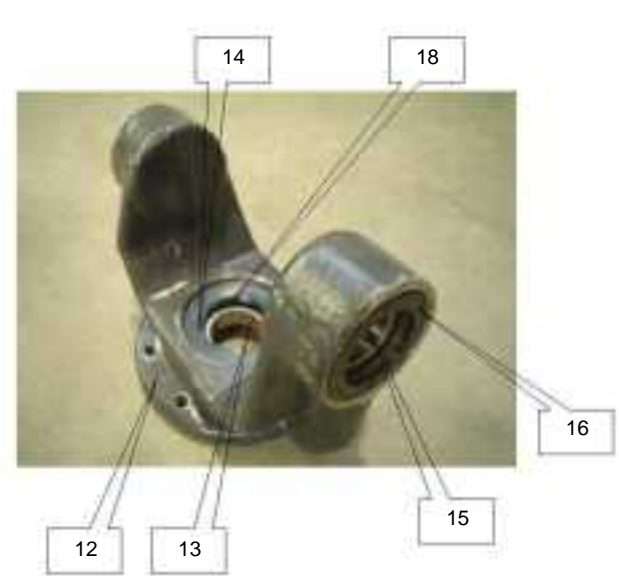
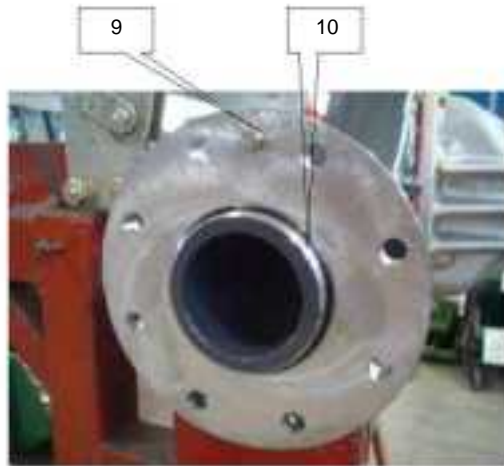
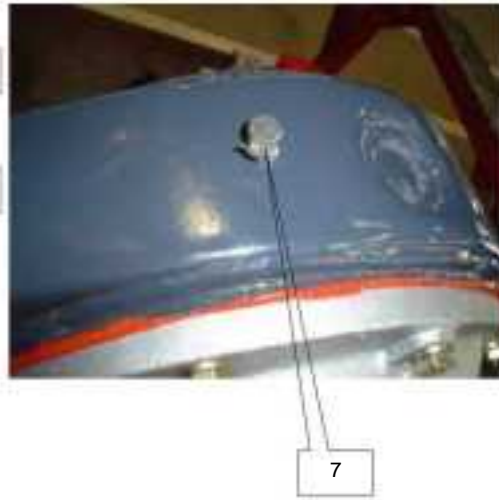
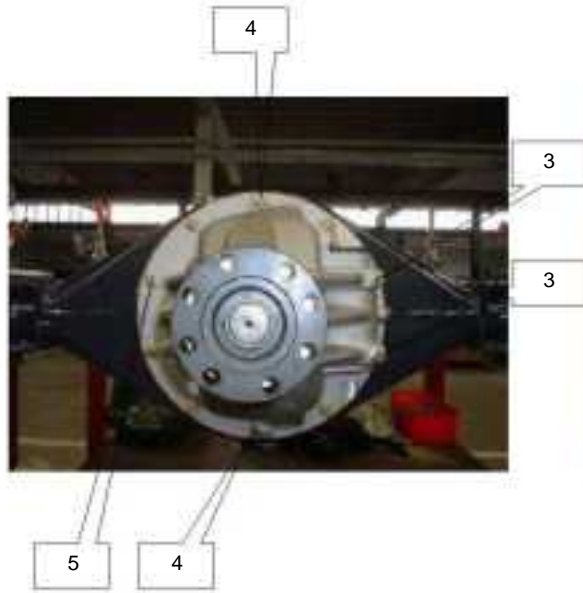

PONTE ANTERIORE

BREMACH

Pos	Codice	Descrizione	Q.tà
3	201032	SCREW (VITE M8X80 UNI 5737-65)	2
4	201024	SCREW (VITE M8X35)	2
5	201023	SCREW (VITE M8X30 UNI 5739-65 ZINCOTR)	2
7	80751	CAP (TAPPO SFIATO)	1
8	A7005	CAP (TAPPO M20X1,5)	1
9	A2033	PLUG (SPINA DI RIFERIM. 8X15)	2
10	B1002	OR (OR 3256)	2
11	91B4020	JOINT (GIUNTO DOPPIO ANT. SENZA BLOCC. DIFFER.)	1
11	91B4021	JOINT (GIUNTO DOPPIO ANT. CON BLOCC. DIFFER.)	1
12	B1007	JOINT (SNODO INTERNO)	1
13	B1004	BEARING (CUSCINETTO 6207 35X72X17)	1
14	B1006	SEAL (GUARNIZIONE MIM BASL 45X72X8)	1
15	B1017	BEARING (CUSCINETTO 33205J 25X52X22)	2
16	B1015	SEAL (GUARNIZIONE MIM BASL 35X55X10)	1
18	B1005	SEEGER (SEEGER I 72)	1

PONTE ANTERIORE

BREMACH

BREMACH

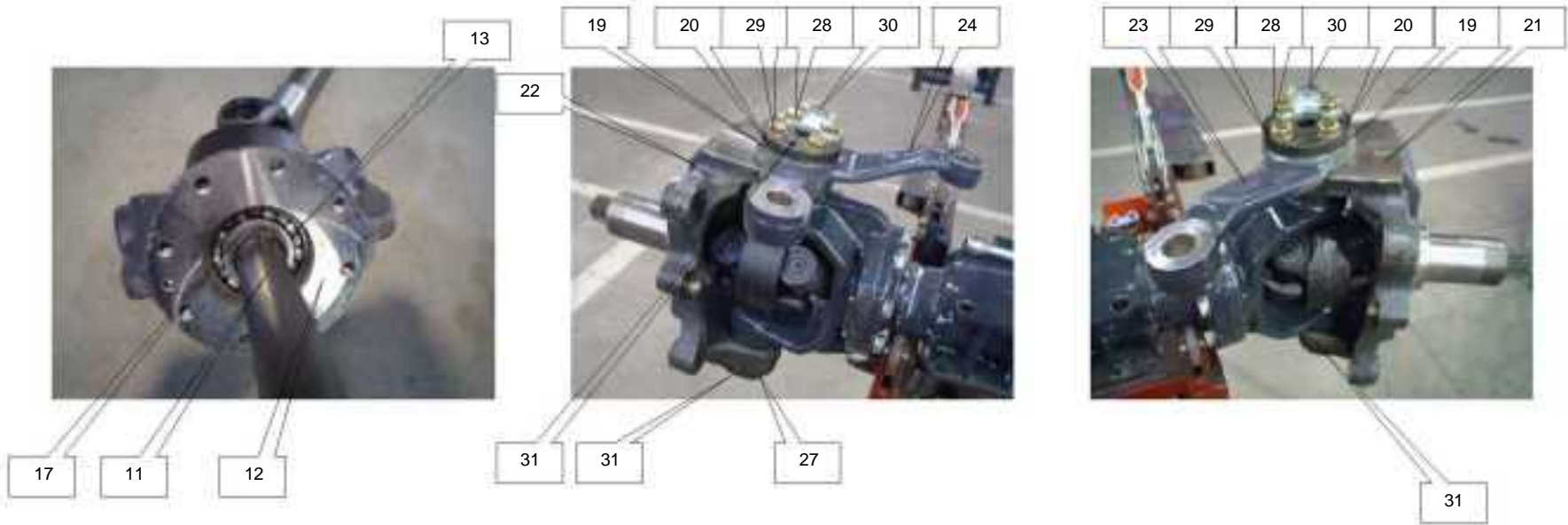

PONTE ANTERIORE

Pos	Codice	Descrizione	Q.tà
11	91B4020	JOINT (GIUNTO DOPPIO ANT. SENZA BLOCC. DIFFER.)	1
11	91B4021	JOINT (GIUNTO DOPPIO ANT. CON BLOCC. DIFFER.)	1
12	B1007	JOINT (SNODO INTERNO)	1
13	B1004	BEARING (CUSCINETTO 6207 35X72X17)	1
17	B1003	SEEGER (SEEGER E 35 UNI 7435)	1
19	B1013	SHIM (RASAMENTO)	1
20	B1010	PIVOT (PERNO SNODO RUOTE)	2
21	91B4011D	HALF JOINT (SEMISNODO EST. DX CON BRONZ.)	1
22	91B4011S	HALF JOINT (SEMISNODO EST. SX CON BRONZ.)	1
23	B1012	LEVER (LEVA SEMPLICE STERZO DX)	1
24	B1011	LEVER (LEVA RUOTA SX)	1
25	B1014	PLUG (SPINA DI RIFERIMENTO LEVE STERZO)	2
26	B1023	RING (ANELLO TENUTA 35X47X7)	2
27	201039	SCREW (VITE M10X35 UNI 5737-65 ZINCOTR)	1
28	201044	SCREW (VITE M10X45)	1
29	203004	WASHER (RONDELLA D.10)	1
30	D4034	PLAQUE (PIASTRINA PER TUBI FRENO)	2
31	QT1268	LUBRICATOR (INGRASSATORE M6X1 L 30 mm)	2
32	91B4008	HUB (MOZZO ANTERIORE)	2
33	95A4005	BEARING (CUSCINETTO MOZZO RUOTA POSTER.)	2
34	91B4016	WHEEL (RUOTA FONICA PONTE ANTER. Z48)	2
35	201011	SCREW (VITE TE M6X16)	6

PONTE ANTERIORE

BREMACH

BREMACH



2A 2B

2C 2D



2

PONTE POSTERIORE

BREMACH

Pos	Codice	Descrizione	Q.tà
1	OSS2P00003	STRUCTURE (STRUTTURA PONTE POS. 6,0 TONN. SOSP EST.)	1
2	DIFFP00051	DIFFERENTIAL (DIFFERENZIALE 10/45 BL=SI)	1
2	DIFFP00052	DIFFERENTIAL (DIFFERENZIALE 9/46 BL=SI)	1
2	DIFFP00064	DIFFERENTIAL (DIFFERENZIALE POST 10/45 BL=SI 60 Q.li)	1
2	DIFFP00065	DIFFERENTIAL (DIFFERENZIALE POST 9/46 BL=SI 60 Q.li)	1
2C	PON2P00015	DIFFERENTIAL (DIFFERENZIALE 10/45 60 Q.LI)	1
2D	PON2P00016	DIFFERENTIAL (DIFFERENZIALE 10/45 60 Q.LI)	1
2A	PON6P00000	DIFFERENTIAL (DIFFERENZIALE 10/45 35 Q.LI)	1
2B	PON6P00001	DIFFERENTIAL (DIFFERENZIALE 9/46 35 Q.LI)	1

PONTE POSTERIORE

BREMACH



17

BREMACH



21

18

23

22

19

20



24A

26

25



24B2

24B4

24B1

24B3



27

28



30

30

PONTE POSTERIORE

BREMACH

Pos	Codice	Descrizione	Q.tà
17	I-99433826	CAP (TAPPO PER CAVO SENSORE ABS)	2
18	95A4005	BEARING (CUSCINETTO MOZZO RUOTA POSTER.)	2
19	91A4015	HUB (MOZZO RUOTA POST. ABS-35/50 Q.LI)	1
19	91A4022	HUB (MOZZO RUOTA POST. ABS-60 Q.LI)	1
20	90B1003	STUD BOLT (COLONNETTA PER PROTEZIONE DIFF. ANT)	1
21	91A4010	COVER (COPERCHIO RUOTA FONICA)	2
22	201021	SCREW (VITE M8X35)	1
23	91A4018	WHEEL (RUOTA FONICA PONTE POS. Z48)	2
24B3	201227	SCREW (VITE M14X2X60 UNI 5931)	5
24B4	203213	COLLAR (ROSETTA EL. 14,2X21,1X3 DIN 7980)	5
24A	91A4016	DISK (DISCO FRENO POSTERIORE 35/50 Q.LI)	2
24B1	91A4023	DISK (DISCO FRENO POSTERIORE 60Q.LI)	2
24B2	91C5012	SPACER (Distanziale POST. Completo)	2
25	211015	SCREW (VITE M10X35X1,25)	12
26	91A4013	COLLAR (ROSETTA DI SICUREZZA POSTERIORE ABS)	2
27	91A4012	RING NUT (GHIERA M55X1,5 POSTER.)	2
28	201175	SCREW (VITE M6X14 UNI 5931)	2
30	201023	SCREW (VITE M8X30 UNI 5739-65 ZINCOTR)	2
30	201024	SCREW (VITE M8X35)	2
30	201032	SCREW (VITE M8X80 UNI 5737-65)	2
30	203003	COLLAR (ROSETTA CON. EL. 8X16X1,9)	2

PONTE POSTERIORE

BREMACH

BREMACH

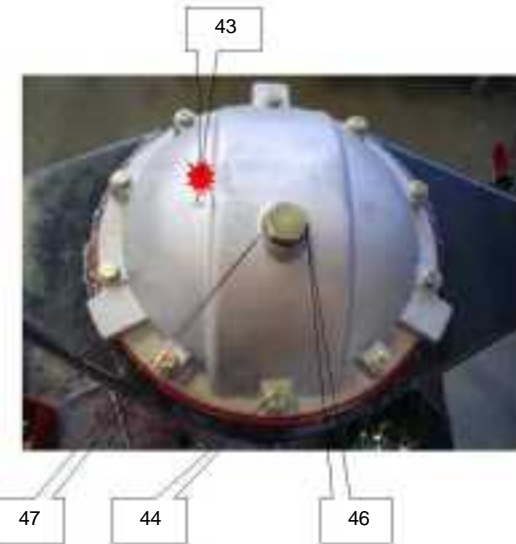
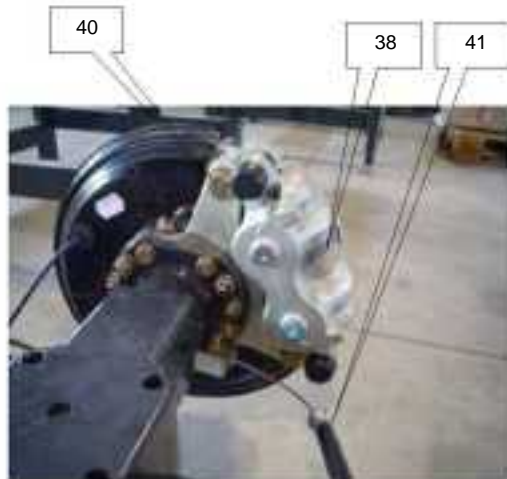
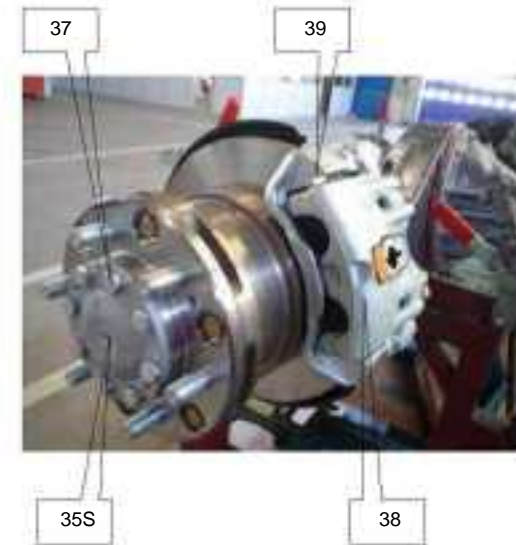
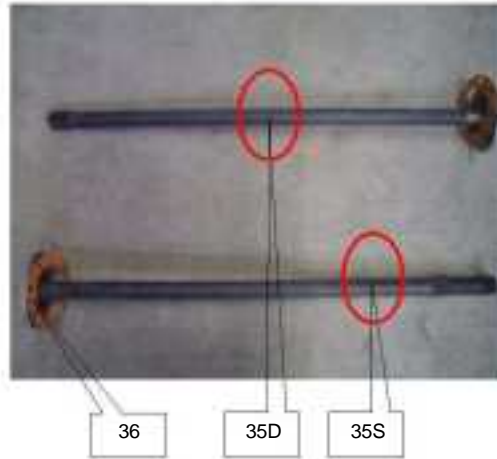
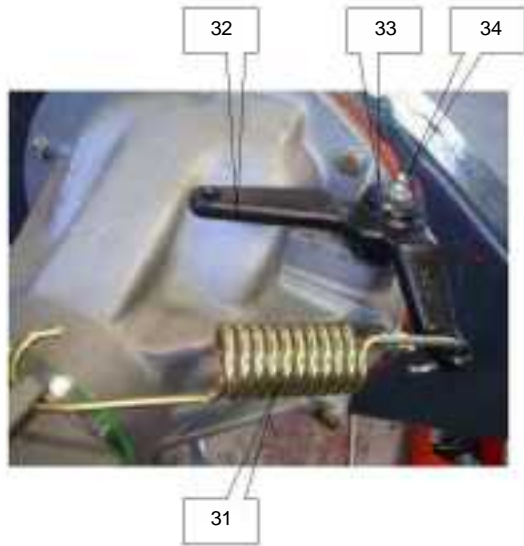

PONTE POSTERIORE

BREMACH

Pos	Codice	Descrizione	Q.tà
31	90A2022	SPRING (MOLLA DI RICHIAMO)	1
32	90A2007	LEVER (LEVA DOPPIA COMANDO BL. DIFF.)	1
33	A9545	SEEGER (SEEGER E 18)	1
34	83375	LUBRICATOR (INGRASSATORE)	2
35D	90A4012	AXLE SHAFT (SEMIASSE POSTERIORE DENT. CORTA D. 30)	1
35S	90A4013	AXLE SHAFT (SEMIASSE POSTERIORE DENT. LUNGA D. 30)	1
35D	91A4027	AXLE SHAFT (SEMIASSE POSTERIORE DENT. CORTA D. 35)	1
35S	91A4028	AXLE SHAFT (SEMIASSE POSTERIORE DENT. LUNGA D. 35)	1
36	90A4003	SEAL (GUARNIZIONE MOZZO)	1
37	211016	SCREW (VITE M10X40X1,25 UNI 5738)	1
38	91F1006D	CALIPER (PINZA FRENO POSTER. DX PF2.46 ABS)	1
38	91F1006S	CALIPER (PINZA FRENO POSTER. SX PF2.46 ABS)	1
39	91F1013	BRAKE PADS (PASTIGLIE-FRENO)	1
40	201615	SCREW (VITE M14X40X1,5 UNI 5740 AUTOBL.)	1
41	91L4013	ROPE (FUNNE FRENO A MANO 4X4)	2
42	90A2010	PLUG (SPINA DI COLLEGAMENTO)	2
43	90A2008	CAP (CALOTTA DIFFERENZIALE)	1
44	201026	SCREW (VITE M8X40)	1
46	80753	CAP (TAPPO CARICO OLIO)	1
47	80754	SEAL (GUARNIZIONE TAPPO D.20X30X2 RAME)	1

PONTE POSTERIORE

BREMACH

BREMACH

48



PONTE POSTERIORE

BREMACH

Pos	Codice	Descrizione	Q.tà
48	90T1021	PLATE (TARGHETTA ASSALE POSTERIORE 1:5,111)	1
48	90T1053	PLATE (TARGHETTA ASSALE POSTERIORE 1:4,5)	1

PONTE POSTERIORE

BREMACH

BREMACH



6

70

111 175 35

111 175

175 150

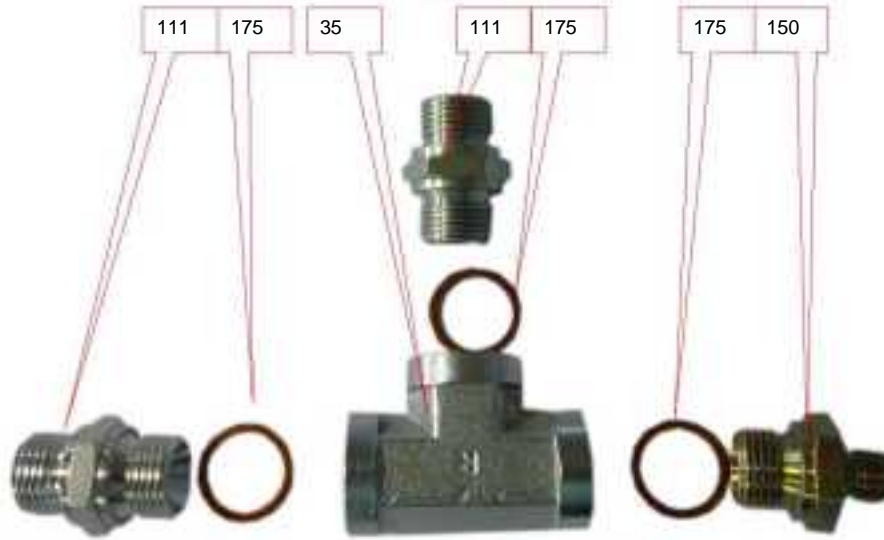

COMANDI IDRAULICI

BREMACH

Pos	Codice	Descrizione	Q.tà
6	96D9116	BRACKET (STAFFA)	1
35	91K1203	"PIPE SOCKET (RACCORDO ADATTATORE A ""T"" ART. 102 1/2"") "	1
70	96L3010	TUBE (TUBO RITORNO OLIO CILINDR.)	1
111	91K1204	PIPE SOCKET (RACCORDO NIPPLO CIS 1/2)	2
150	91K1214	PIPE SOCKET (RACCORDO NIPPLO CIS 1/4 CIS 1/2)	1
175	96K1200	COLLAR (ROSETTA IN CU 17X27X1,5)	3

COMANDI IDRAULICI

BREMACH

BREMACH

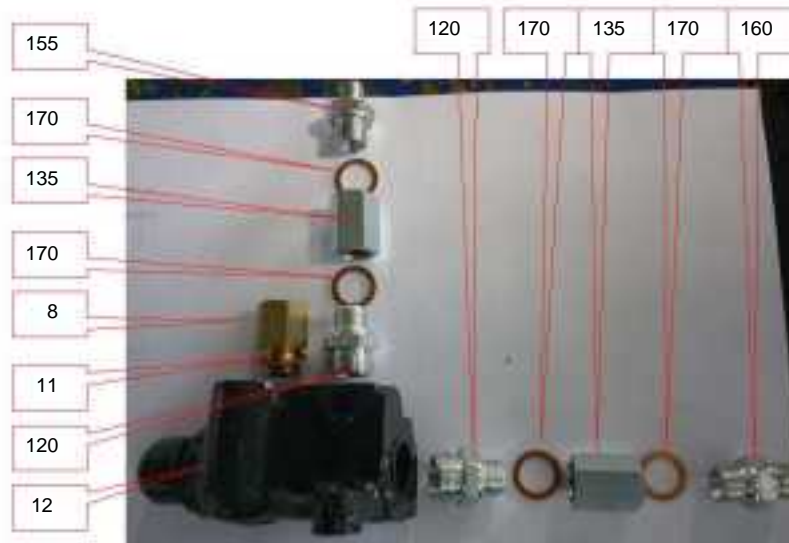

COMANDI IDRAULICI

BREMACH

Pos	Codice	Descrizione	Q.tà
7	96L3030	SUPPORT (SUPPORTO VALVOLA F1C 17CV)	1
8	91D1033	PIPE SOCKET (RACCORDO INNESTO)	1
11	91D1034	ROSETTA IN RAME	1
12	96L3003	VALVE (VALVOLA IDRAULICA F1C)	1
12	96L3028	VALVE (VALVOLA IDRAULICA F1A)	1
120	96L3025	"PIPE SOCKET (RACCORDO TN92-15LR 3/8") "	2
135	96L3027	"SLEEVE (MANICOTTO PER OLIO 3/8") "	2
155	91K1224	PIPE SOCKET (RACCORDO NIPPLO CIS 3/8 CIS 3/8)	2
160	91K1212	PIPE SOCKET (RACCORDO NIPPLO CIS 1/4 CIS 3/8)	1
170	91K1241	COLLAR (ROSETTA IN CU 17X23X1,5)	4

COMANDI IDRAULICI

BREMACH

BREMACH

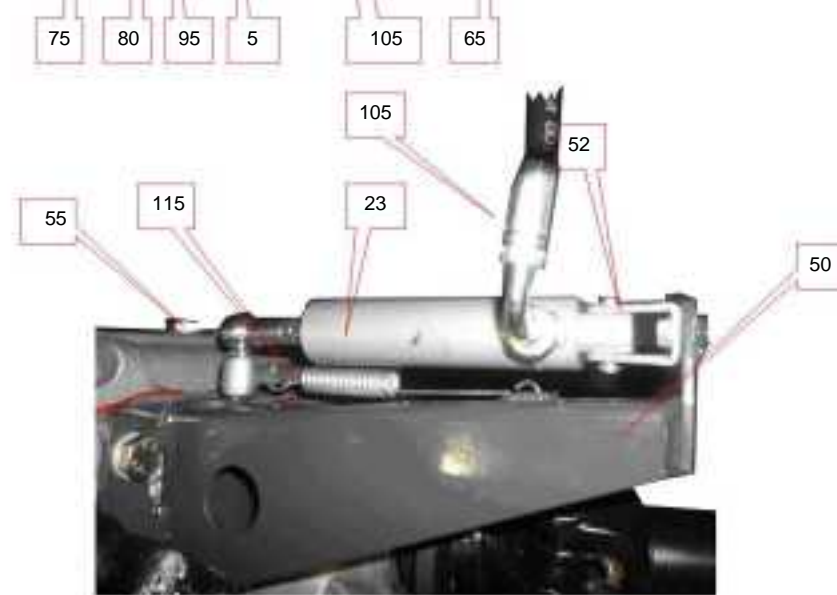
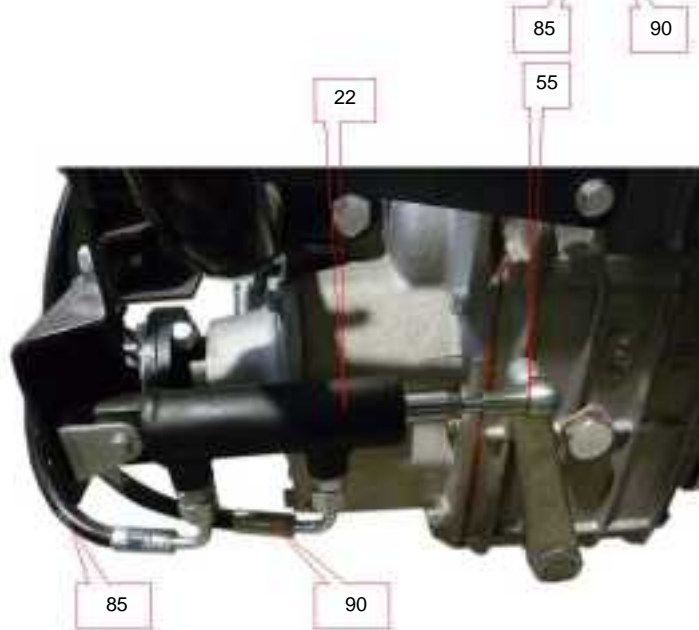
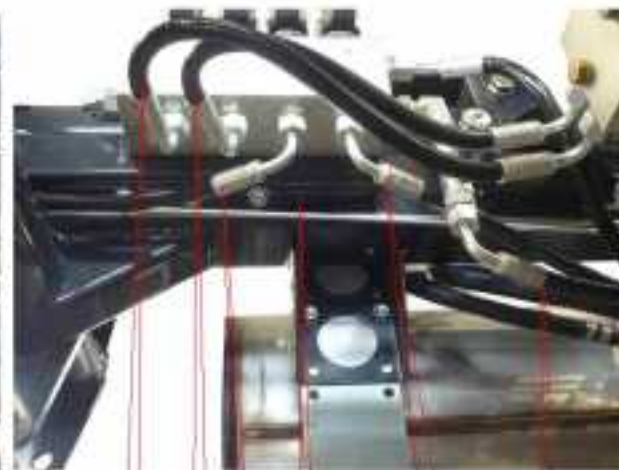
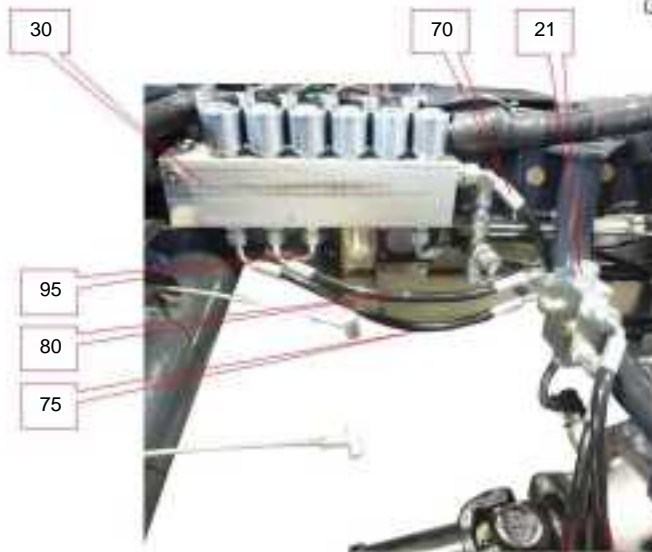

COMANDI IDRAULICI

Pos	Codice	Descrizione	Q.tà
5	96L3001	BRACKET (STAFFA FISSAGGIO CENTR. COM. IDRAULICI)	1
21	96L3034	VALVE (VALVOLA)	1
22	96L3037	CYLINDER (CILINDRO)	1
23	96L3035	CYLINDER (CILINDRO RIDOTTE)	1
30	96L3002	KIT (KIT COMANDI IDRAULICI 6 EL.)	1
30	96L3052	KIT (KIT COMANDI IDRAULICI 4 EL.)	1
50	96L3006	SUPPORT (SUPPORTO PER PISTONE 3°DIFFERENZIALE)	1
52	96L3020	SUPPORT (SUPPORTO PISTONE BLOCC. DIFFERENZIALE)	1
55	96L3007	PIVOT (PERNO SNODATO PER COMANDI)	4
65	96L3009	TUBE (TUBO MANDATA OLIO CILINDR.)	1
70	96L3010	TUBE (TUBO RITORNO OLIO CILINDR.)	1
75	96L3011	"TUBE (TUBO DA CILINDR. ""B"" A VALVOLA) "	1
80	96L3012	"TUBE (TUBO DA CILINDR. ""A"" A VALVOLA) "	1
85	96L3013	"TUBE (TUBO DA VALVOLA ""C2"" A PIST. RIDOTT.) "	1
90	96L3014	"TUBE (TUBO DA VALVOLA ""C1"" A PIST. RIDOTT.) "	1
95	96L3015	"TUBE (TUBO DA CILINDR. ""BP"" A PONTE POSTERIORE P.2600/3100) "	1
105	96L3017	TUBE (TUBO DA CILINDR. A PIST. 3°DIFFERENZIALE)	1
115	90M1332	SPRING (MOLLA DI RICHIAMO)	2

BREMACH

BREMACH

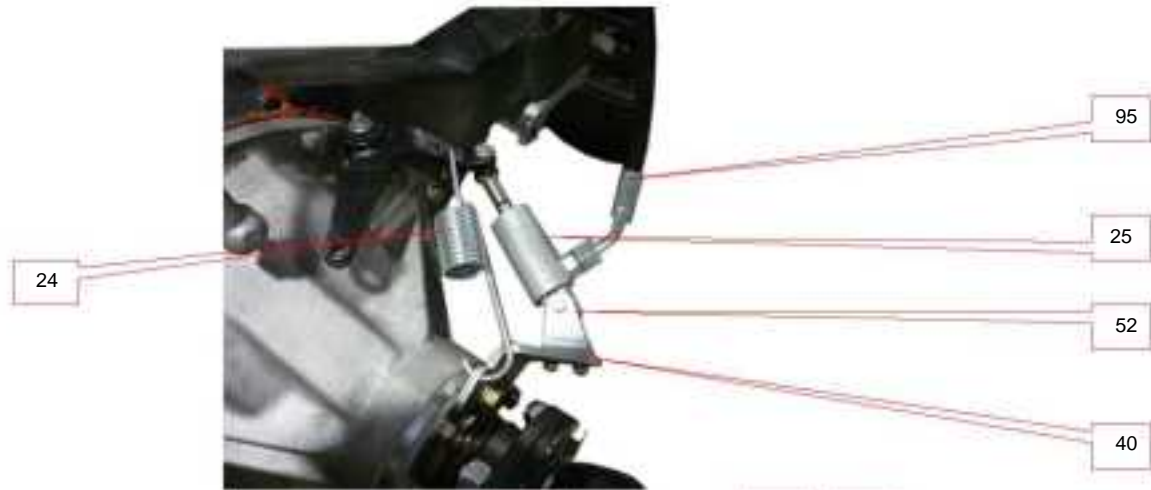

COMANDI IDRAULICI

Pos	Codice	Descrizione	Q.tà
24	90A2022	SPRING (MOLLA DI RICHIAMO)	1
25	96L3036	CYLINDER (CILINDRO)	1
26	96L3061	VALVE (ELETTRIVALVOLA)	1
27	96L3033	DISTRIBUTOR (BLOCCO-DISTRIBUTORE 6 VALVOLE)	1
27	96L3053	DISTRIBUTOR (BLOCCO-DISTRIBUTORE 4 VALVOLE)	1
40	96L3004	BRACKET (STAFFA PER CIL. BLOCC. DIFFERENZIALE)	1
52	96L3020	SUPPORT (SUPPORTO PISTONE BLOCC. DIFFERENZIALE)	1
60	91K1207	PIPE SOCKET (RACCORDO NIPPLO CIS 1/4 CIS 1/4)	15
61	96L3023	WASHER (RONDELLA IN CU 13,5X19X1,5)	15
95	96L3015	"TUBE (TUBO DA CILINDR. ""BP"" A PONTE POSTERIORE P.2600/3100) "	1
130	96L3026	VALVE (VALVOLA PROVA PRESSIONE)	1
140	91K1208	PIPE SOCKET (RACCORDO ADATTATORE M 1/4 FG 1/4)	1
145	91K1213	PIPE SOCKET (RACCORDO ADATTATORE 90 MF 1/4 SERIE PES)	1
165	91K1206	PIPE SOCKET (RACCORDO ADATTATORE AT ART. 102 1/4)	1

BREMACH

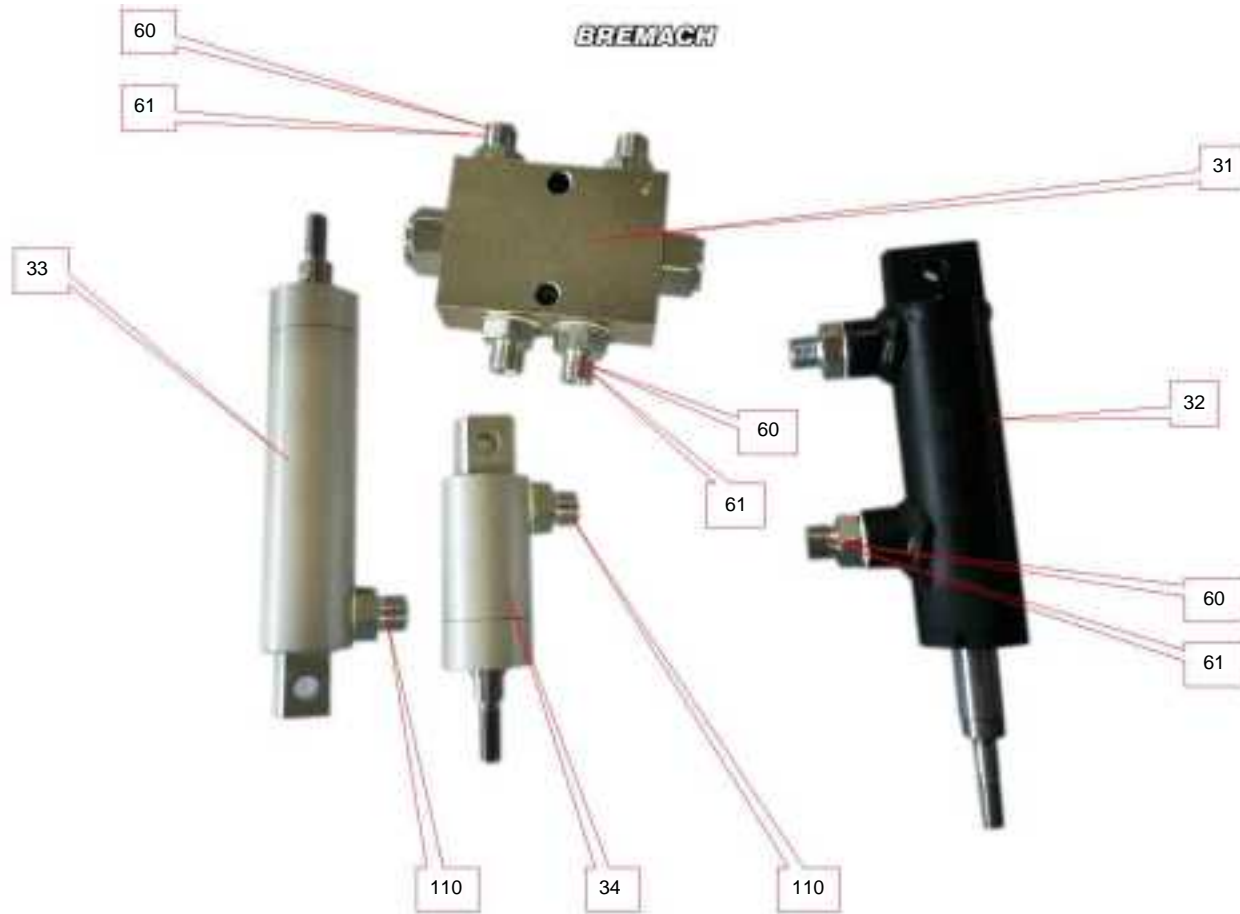

COMANDI IDRAULICI

BREMACH

Pos	Codice	Descrizione	Q.tà
31	96L3034	VALVE (VALVOLA)	1
32	96L3037	CYLINDER (CILINDRO)	1
33	96L3035	CYLINDER (CILINDRO RIDOTTE)	1
34	96L3036	CYLINDER (CILINDRO)	1
60	91K1207	PIPE SOCKET (RACCORDO NIPPLO CIS 1/4 CIS 1/4)	15
61	96L3023	WASHER (RONDELLA IN CU 13,5X19X1,5)	15
110	96L3019	PIPE SOCKET (RACCORDO NIPPLO CIS 1/4 COS 1/8)	3

COMANDI IDRAULICI

BREMACH

BREMACH



- 1
- 3
- 20
- 2
- 4

PNEUMATICO

BREMACH

Pos	Codice	Descrizione	Q.tà
1	90C5014	"CIRCLE (CERCHIO 16"" 6.50H) "	5
1	91C5003	CIRCLE (CERCHIO 17.5X6.00 - 3,5 TONN.)	5
1	91C5008	CIRCLE (CERCHIO 17.5X6.75 - 6,0 TONN.)	5
2	90C5005	VALVE (VALVOLA R 17,5X6,00)	5
2	91C5001	"VALVE (VALVOLA 16"" 6,50) "	5
3	91C5029	NUT (DADO PER COLONNETTA (ZINCATO))	24
4	90C5011	TIRE (PNEUMATICO 225/75/17,5)	5
4	90C5012	TIRE (PNEUMATICO 255/100/R16)	5
4	91C5010	TIRE (PNEUMATICO 245/70/R17,5)	5
20	91C5002	"SEAL (GUARNIZIONE CERCHIO 16"") "	4

PNEUMATICO

BREMACH

BREMACH



PARAFANGO POSTERIORE BRICK

BREMACH

Pos	Codice	Descrizione	Q.tà
5	96N9108	MUDGUARD (PARAFANGO POSTERIORE)	2
10	90S9125D	BRACKET (STAFFA DX)	2
15	90S9125S	BRACKET (STAFFA SX)	2
20	90N1502	PLAQUE (PIASTRINA INT. PARAFANGO)	4
25	201020	SCREW (VITE M8X16)	8
30	201011	SCREW (VITE TE M6X16)	8
31	203002	WASHER (RONDELLA D.6)	8
35	16750121	NUT (DADO FLANGIATO M6)	8
50	96N9103	SEALING STRIP (PARASPRUZZI)	2
55	E4169	SCREW (RIVETTO 4,9X16)	6
60	203102	WASHER (RONDELLA PIANA 5X16X1,6)	6

PARAFANGO POSTERIORE BRICK

BREMACH

BREMACH

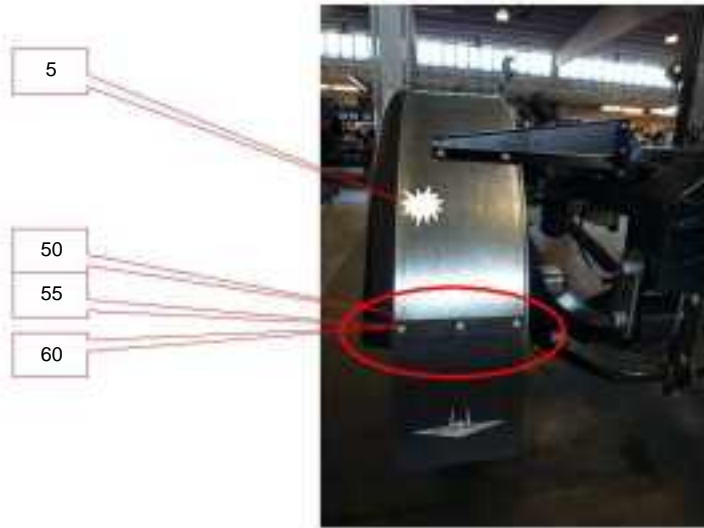

PARAFANGO POSTERIORE EXTREME

BREMACH

Pos	Codice	Descrizione	Q.tà
5	91N1500	MUDGUARD (PARAFANGO POSTERIORE)	2
10	90S9125D	BRACKET (STAFFA DX)	4
15	90S9125S	BRACKET (STAFFA SX)	12
20	90N1502	PLAQUE (PIASTRINA INT. PARAFANGO)	8
25	201020	SCREW (VITE M8X16)	4
26	203003	COLLAR (ROSETTA CON. EL. 8X16X1,9)	8
30	201011	SCREW (VITE TE M6X16)	8
31	203002	WASHER (RONDELLA D.6)	8
35	16750121	NUT (DADO FLANGIATO M6)	8
40	90N1508	SUPPORT (SUPPORTO PER STAFFA)	4
42	201020	SCREW (VITE M8X16)	4
45	16750221	NUT (DADO EF M8)	8
50	96N9103	SEALING STRIP (PARASPRUZZI)	6
55	E4169	SCREW (RIVETTO 4,9X16)	6
60	203102	WASHER (RONDELLA PIANA 5X16X1,6)	4

PARAFANGO POSTERIORE EXTREME

BREMACH

BREMACH

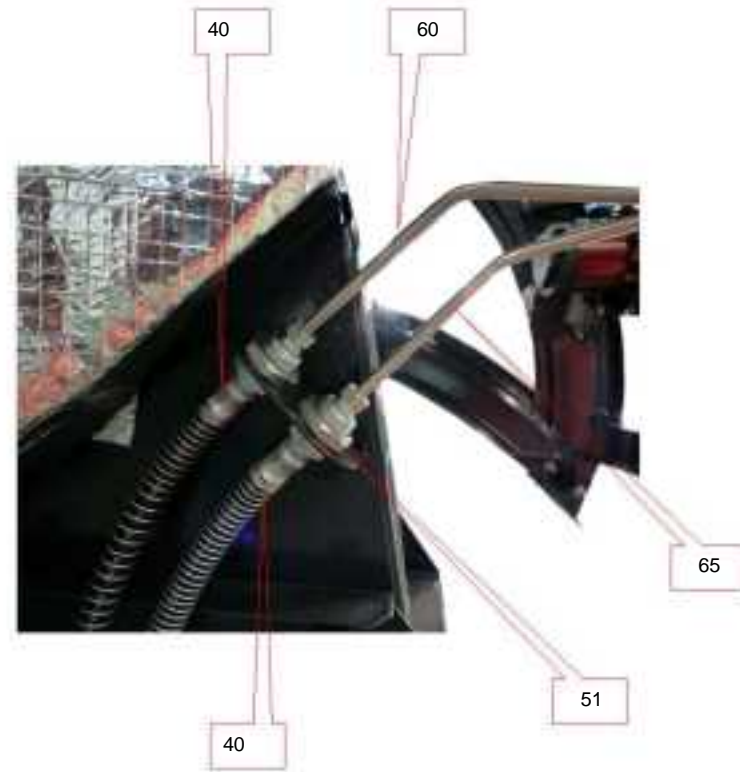

IMPIANTO FRENANTE

BREMACH

Pos	Codice	Descrizione	Q.tà
40	95F1018	TUBE (TUBO FESSIBILE ANTER.)	2
51	82269	NUT (DADO FISSAGGIO TUBO)	2
60	96F1019	TUBE (TUBO DA FLESSIBILE A SERVOFR.)	1
65	96F1020	TUBE (TUBO DA FLESSIBILE A SERVOFR.)	1

IMPIANTO FRENANTE

BREMACH

BREMACH

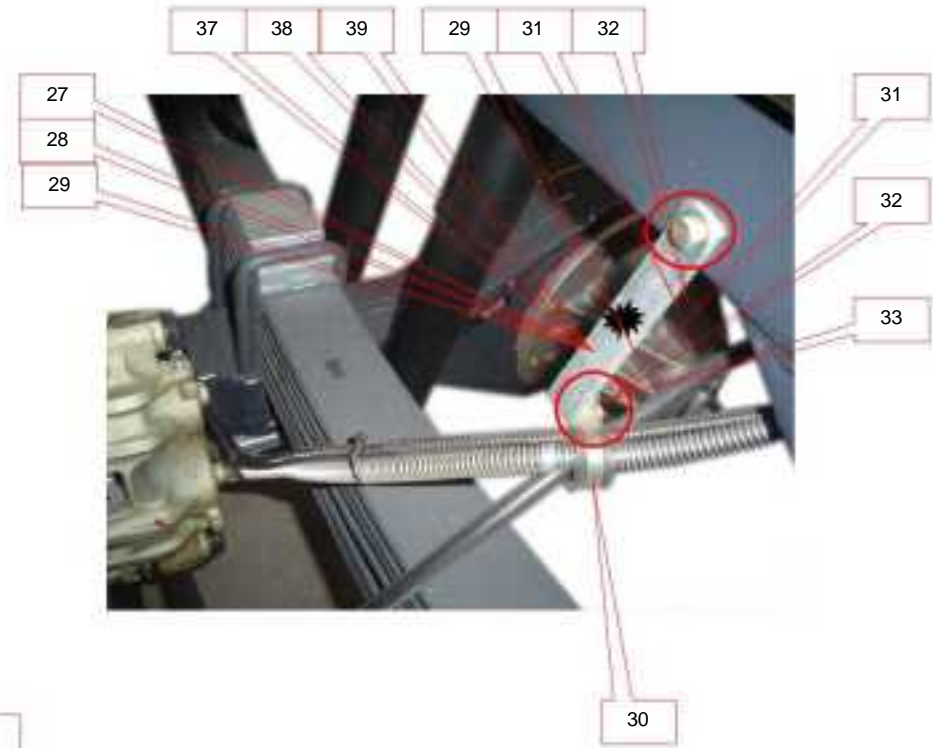
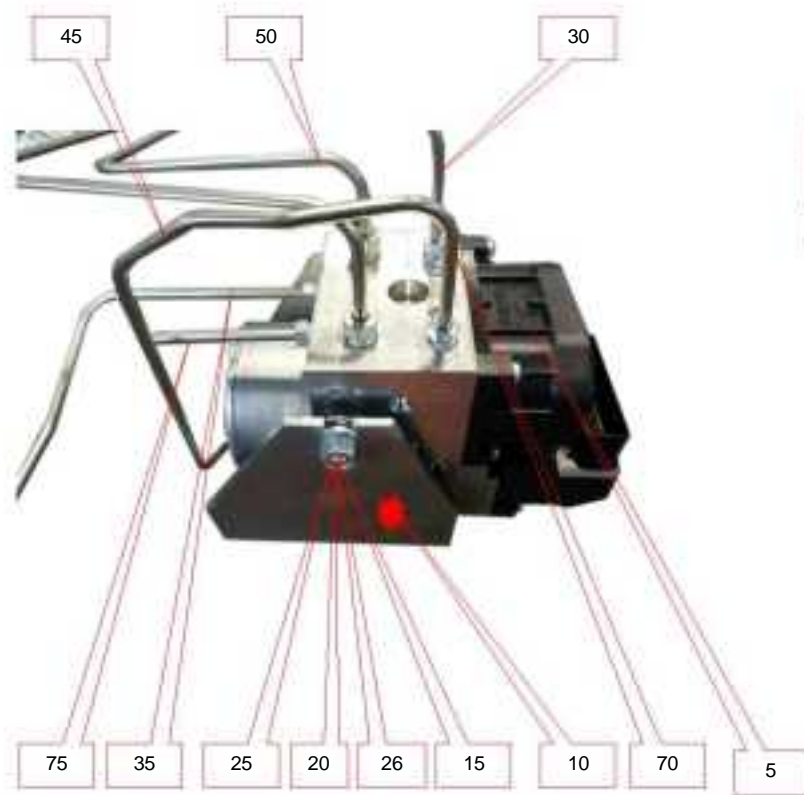

IMPIANTO FRENANTE

BREMACH

Pos	Codice	Descrizione	Q.tà
5	91F1016	GEARCASE (CENTRALINA ABS 4X4)	1
10	91P3002	SUPPORT (SUPPORTO CENTRALINA ABS COMPL.)	1
15	201021	SCREW (VITE M8X35)	2
20	203003	COLLAR (ROSETTA CON. EL. 8X16X1,9)	4
25	202004	NUT (DADO M8)	2
26	16750221	NUT (DADO EF M8)	2
27	90L4007	SUPPORT (SUPPORTO CAVO)	2
28	I5014	STIRRUP (STAFFETTA CON GUAINA)	2
29	201011	SCREW (VITE TE M6X16)	10
30	96F1007	TUBE (TUBO DA CENTR. A RUOTA ANTERIORE SX)	1
31	D4034	PLAQUE (PIASTRINA PER TUBI FRENO)	2
32	I5014	STIRRUP (STAFFETTA CON GUAINA)	2
33	201011	SCREW (VITE TE M6X16)	2
35	96F1008	TUBE (TUBO DA CENTR. A RUOTA ANTERIORE DX)	1
37	203002	WASHER (RONDELLA D.6)	10
38	16750121	NUT (DADO FLANGIATO M6)	2
39	Z270010	CLAMP (FASCETTA NYLON)	10
45	96F1009	TUBE (TUBO DA CENTR. A FLESS. SERVOFR.)	1
50	96F1010	TUBE (TUBO DA CENTR. A FLESS. SERVOFR.)	1
70	96F1011	TUBE (TUBO 1 DA CENTR. A CORR. P. 2600)	1
70	96F1012	TUBE (TUBO 1 DA CENTR. A CORR. P. 3100)	1
70	96F1013	TUBE (TUBO 1 DA CENTR. A CORR. P. 3450)	1
75	96F1014	TUBE (TUBO 2 DA CENTR. A CORR. P. 2600)	1
75	96F1015	TUBE (TUBO 2 DA CENTR. A CORR. P. 3100)	1
75	96F1016	TUBE (TUBO 2 DA CENTR. A CORR. P. 3450)	1

IMPIANTO FRENANTE

BREMACH

BREMACH

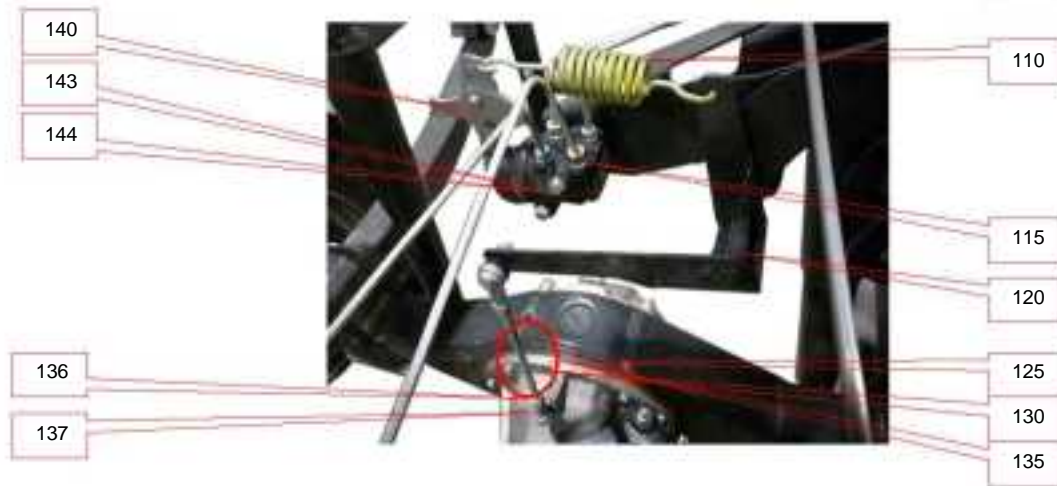
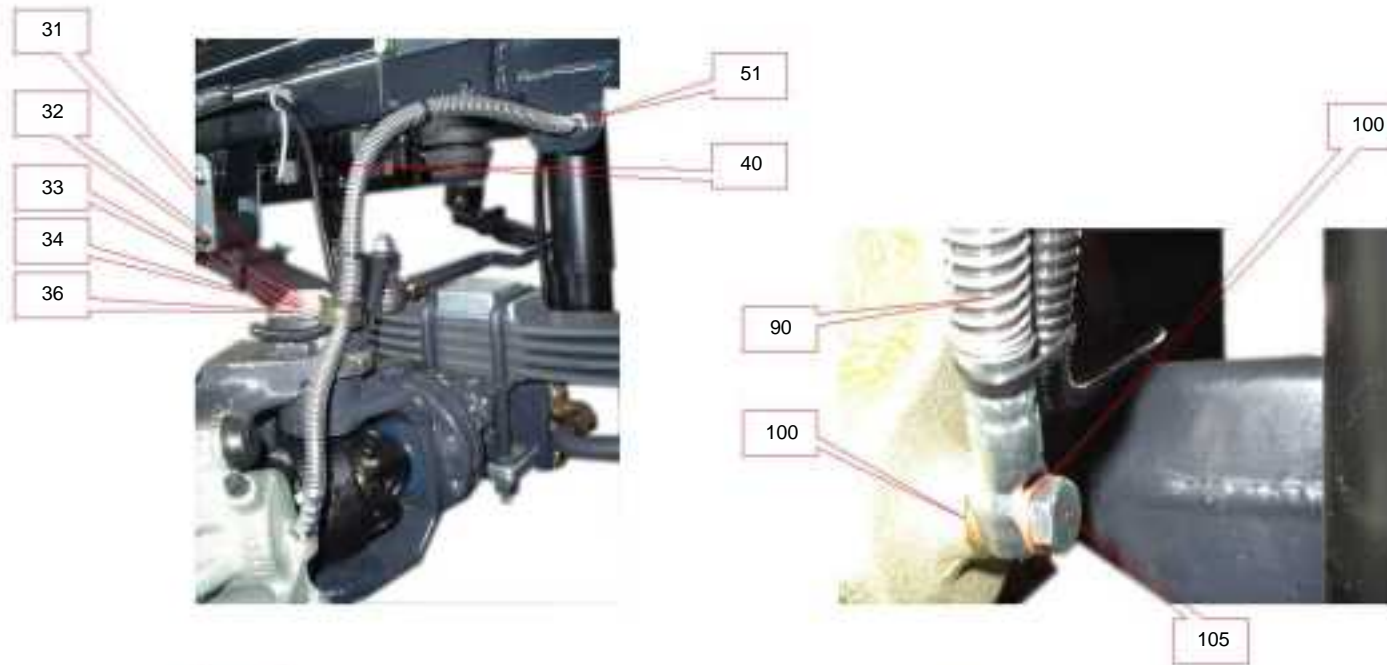

IMPIANTO FRENANTE

BREMACH

Pos	Codice	Descrizione	Q.tà
31	D4034	PLAQUE (PIASTRINA PER TUBI FRENO)	2
32	I5014	STIRRUP (STAFFETTA CON GUAINA)	2
33	201011	SCREW (VITE TE M6X16)	2
34	203002	WASHER (RONDELLA D.6)	2
36	16750121	NUT (DADO FLANGIATO M6)	2
40	95F1018	TUBE (TUBO FESSIBILE ANTER.)	2
51	82269	NUT (DADO FISSAGGIO TUBO)	1
90	91F1059	TUBE (TUBO FLESSIBILE POSTER.)	1
100	83217	SEAL (GUARNIZIONE RAME)	4
105	91F1046	SCREW (VITE CAVA)	2
110	95F1014	SPRING (MOLLA)	1
115	91F1015	SENSOR (SENSORE CORRETTORE DI FRENATA)	1
120	96F1023	LEVER (LEVA CORRETTORE DI FRENATA)	1
125	96F9102	SUCKER ROD (ASTINA)	1
130	83573	JOINT (SNODO DX)	1
135	83574	JOINT (SNODO SX)	1
136	83372	NUT (DADO M8 SX)	1
137	202012	NUT (DADO M8)	1
140	91F1020	BRACKET (STAFFA)	1
143	201229	SCREW (VITE M6X70)	2
144	203002	WASHER (RONDELLA D.6)	2

IMPIANTO FRENANTE

BREMACH

BREMACH



5



15



75

30



35

65



45

46

SERVOFRENO E SERBATOIO DEPRESSIONE

BREMACH

Pos	Codice	Descrizione	Q.tà
5	91F1085	BRAKE BOOSTER (SERVOFRENO)	1
15	95F1057	SEAL (GUARNIZIONE)	1
30	91F1009	TANK (SERBATOIO SERV. 5 LT.)	1
35	96F1005	SUPPORT (SUPPORTO SERBATOIO MY 08)	1
45	81535	PIVOT (PERNO PER FORCELLA)	1
46	205001	SPLIT PIN (COPPIGLIA)	1
65	96F1006	BUSH (BOCCOLA ELASTICA)	1
75	96F1022	TUBE (TUBO DA SERBATOIO A SERVOFRENO)	1

SERVOFRENO E SERBATOIO DEPRESSIONE

BREMACH

BREMACH

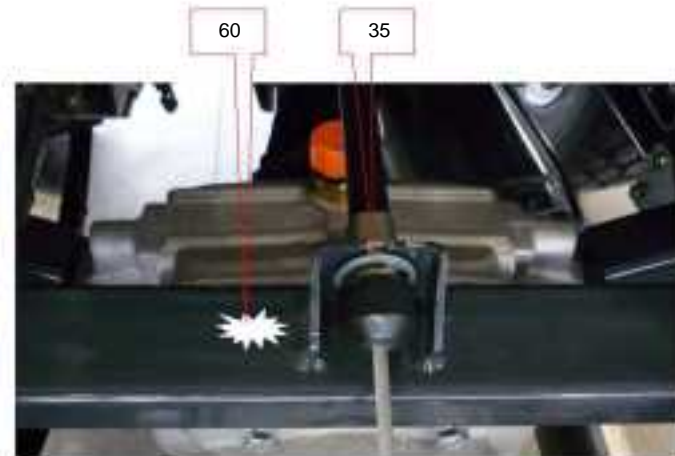
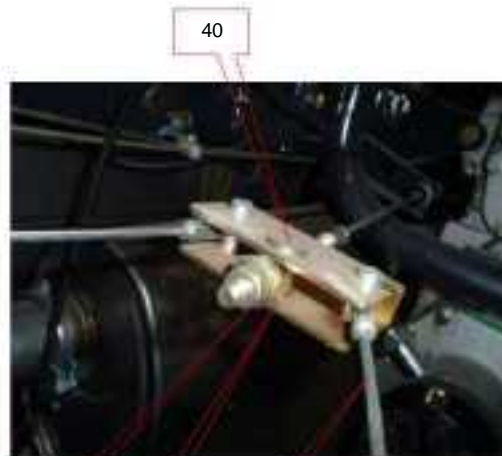

FRENO A MANO

Pos	Codice	Descrizione	Q.tà
5	95L4009	LEVER (LEVA FRENO A MANO)	1
10	16586724	SCREW (VITE TEF M8X40)	4
15	96L4009	ROPE (FUNNE PRIMARIA PASSO 2600)	1
15	96L4010	ROPE (FUNNE PRIMARIA PASSO 3100)	1
15	96L4011	ROPE (FUNNE PRIMARIA PASSO 3450)	1
17	91L4013	ROPE (FUNNE FRENO A MANO 4X4)	2
20	95L4000	PIVOT (PERNO)	1
25	95L4007	RING (ANELLO DI SICUREZZA)	1
35	95L4008	RING (ANELLO ELASTICO)	1
40	95L4004	BRACKET (STAFFA FRENO A MANO)	1
45	95L4003	SPACER (DISTANZIALE)	1
50	95L4002	SLEEVE (MANICOTTO FILETTATO)	1
60	96L4006	CROSS MEMBER (TRAVERSA REAZIONE FRENO A MANO P. 3450)	1
60	96L4007	CROSS MEMBER (TRAVERSA REAZ. FRENO A MANO P. 2600)	1
60	96L4008	CROSS MEMBER (TRAVERSA REAZ. FRENO A MANO P. 3100)	1

FRENO A MANO

BREMACH

BREMACH



25



17



35



40



45



50

FRENO A MANO

BREMACH

Pos	Codice	Descrizione	Q.tà
17	91L4013	ROPE (FUNNE FRENO A MANO 4X4)	2
25	95L4007	RING (ANELLO DI SICUREZZA)	1
35	95L4008	RING (ANELLO ELASTICO)	1
40	95L4004	BRACKET (STAFFA FRENO A MANO)	1
45	95L4003	SPACER (DISTANZIALE)	1
50	95L4002	SLEEVE (MANICOTTO FILETTATO)	1

FRENO A MANO

BREMACH

BREMACH



ALBERO STERZO SNODATO

BREMACH

Pos	Codice	Descrizione	Q.tà
5	96D1002	SHAFT (ALBERO STERZO 1°TRATTO)	1
10	96D1003	SHAFT (ALBERO STERZO 2°TRATTO)	1
50	96D1008	SHAFT (ALBERO CON IDROGUIDA)	1
55	QT1573	JOINT (GIUNTO ELASTICO M.Y. 08)	1
60	96D1011	BRACKET (STAFFA ALBERINO STERZO COMPL. DI BOCCOLE)	1
70	96D1012	BUSH (BOCCOLA IN BRONZO)	2
75	83375	LUBRICATOR (INGRASSATORE)	2
80	90P4070	COMPASS (BUSSOLA M 6)	3

ALBERO STERZO SNODATO

BREMACH

BREMACH

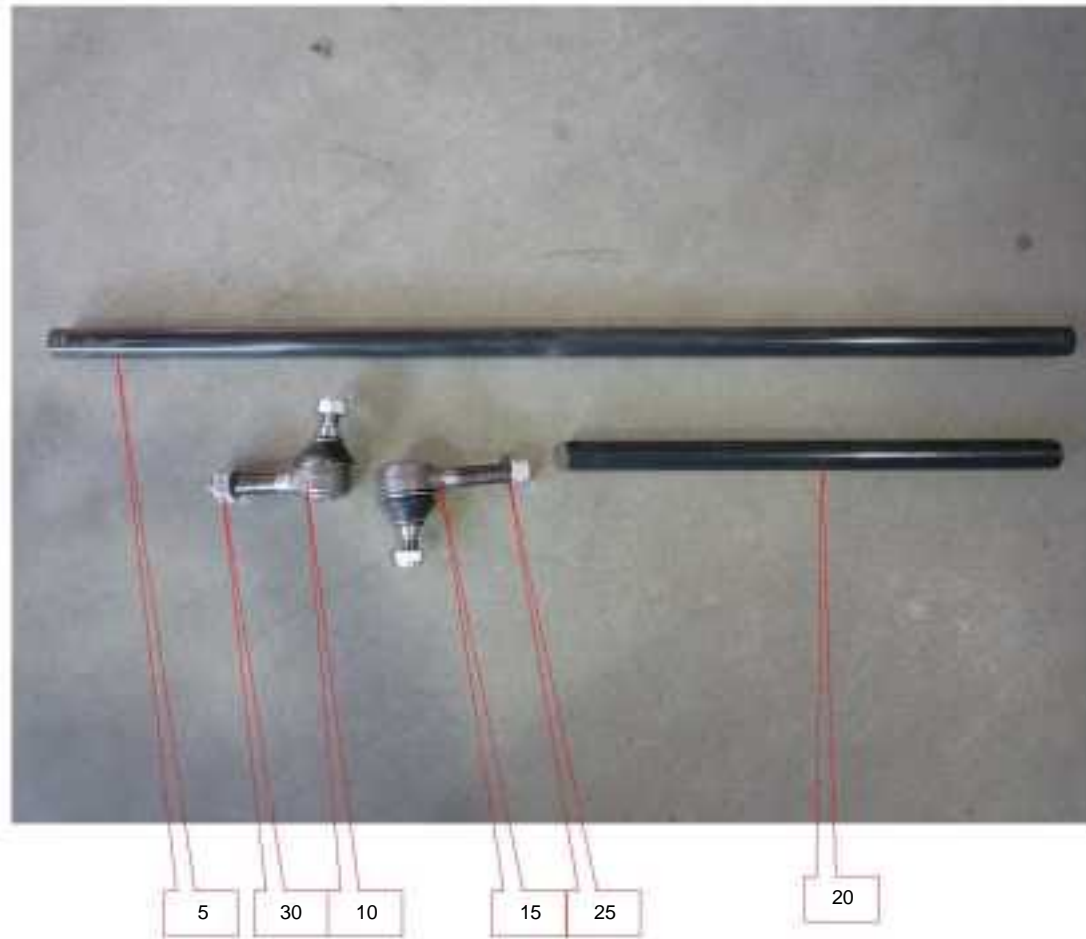

TIRANTE STERZO VEICOLI

Pos	Codice	Descrizione	Q.tà
5	90D1003	TIE-ROD (TIRANTE TRA LEVE SU PONTE ANTER.)	1
10	B7006	JOINT (SNODO IN ACCIAIO DX)	2
15	B7007	JOINT (SNODO IN ACCIAIO SX)	2
20	96D9104	TIE-ROD (TIRANTE LONGITUDINALE STERZO)	1
25	202203	NUT (DADO M18X1,5 H 15 SX UNI 5588)	2
30	202204	NUT (DADO M18X1,5 H 15 DX)	2

TIRANTE STERZO VEICOLI

BREMACH

BREMACH

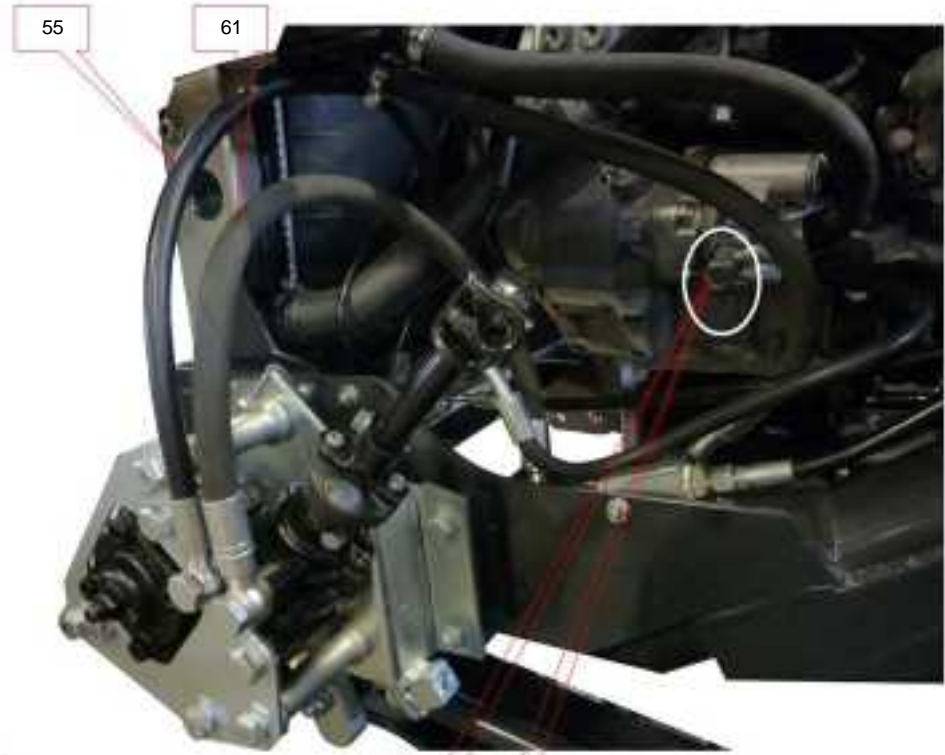
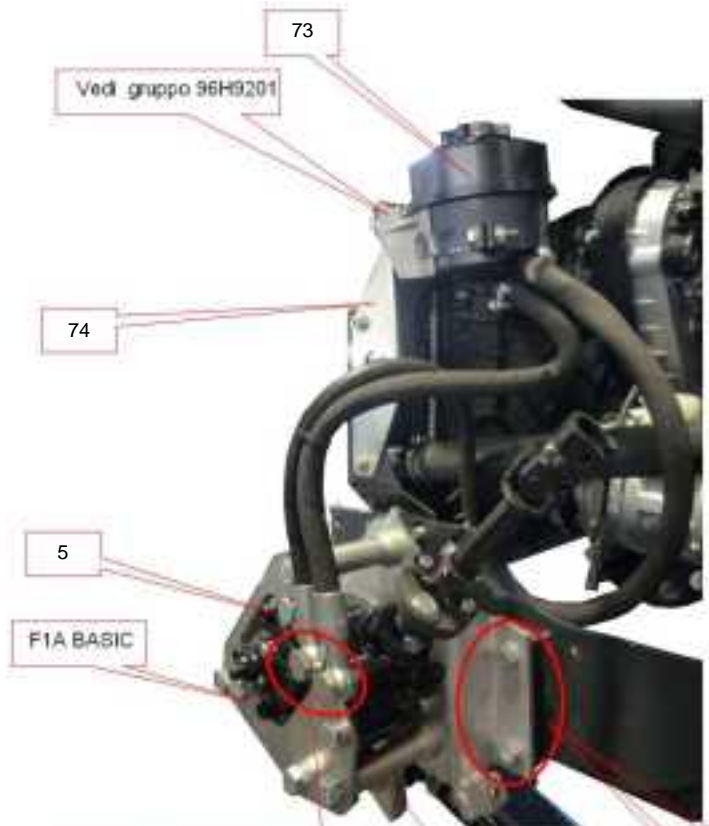

76 75

65 70

70
65

IDROGUIDA

Pos	Codice	Descrizione	Q.tà
5	96D9103	WHOLE (ASSIEME SCATOLA IDROGUIDA)	1
55	96D9106	TUBE (TUBO DA VALVOLA A IDROG.)	1
61	96D9108	"TUBE (TUBO DA IDROG. A RACCORDO A ""T"")	1
65	90D1017	PIPE SOCKET (RACCORDO FORATO MASCHIO M16X1,5)	4
70	90D1018	SEAL (GUARNIZIONE IN CU 16X21X2)	9
73	91D1023	TANK (SERBATOIO OLIO IDROG.)	1
74	96D9113	BRACKET (STAFFA SUPP. SERB. IDROG.)	1
75	201075	SCREW (VITE M12 X 35)	5
76	203005	COLLAR (ROSETTA D. 12)	5

BREMACH

BREMACH



IDROGUIDA

Pos	Codice	Descrizione	Q.tà
61	96D9108	"TUBE (TUBO DA IDROG. A RACCORDO A ""T"")	1
63	96L3003	VALVE (VALVOLA IDRAULICA F1C)	1
63	96L3028	VALVE (VALVOLA IDRAULICA F1A)	1
77	96D9126	BRACKET (STAFFA FISSA RACCORDO 3 VIE)	1

BREMACH

BREMACH

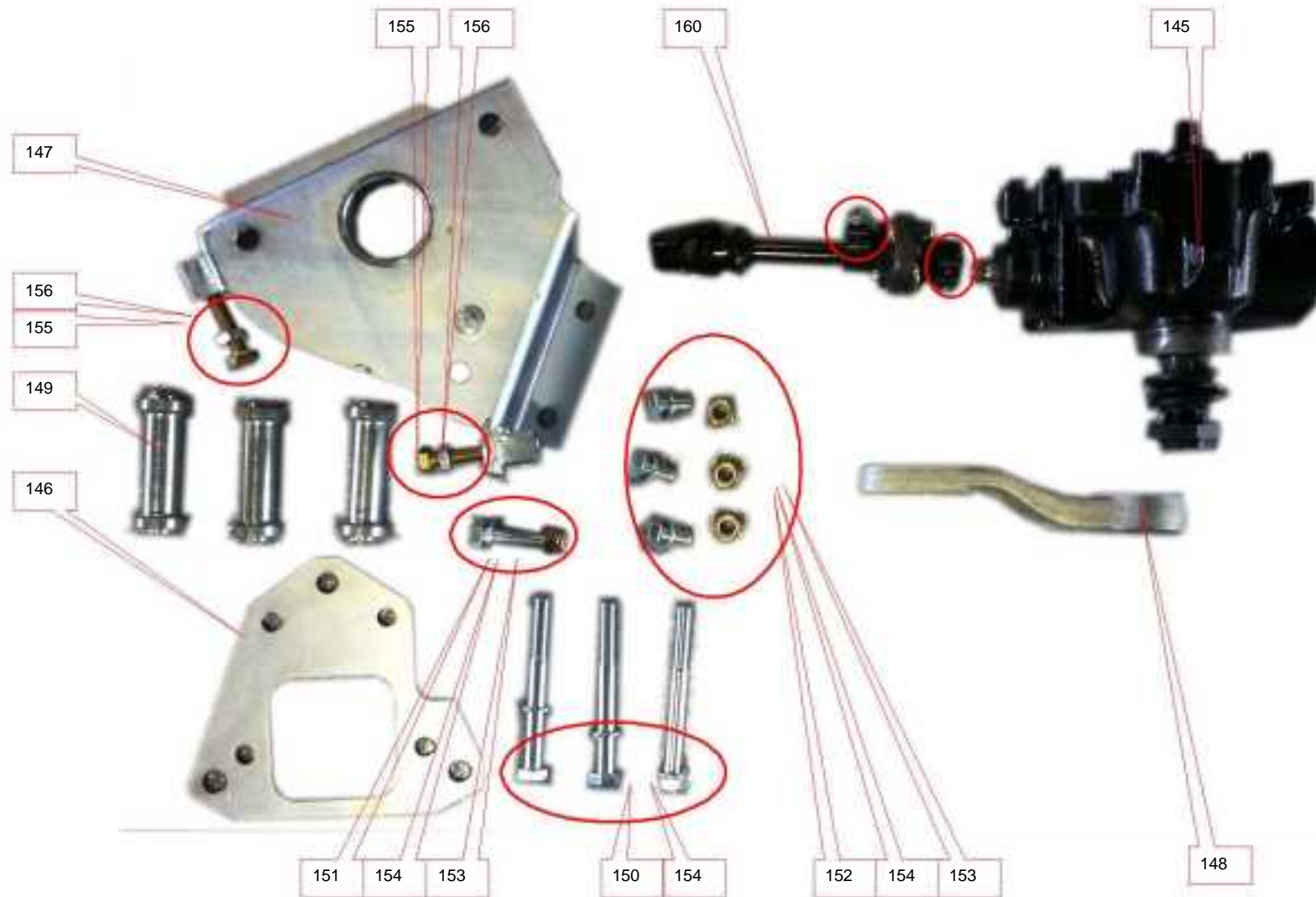

IDROGUIDA

BREMACH

Pos	Codice	Descrizione	Q.tà
145	90D1013	STEERING BOX (IDROGUIDA - F1A - G.SX)	1
146	90D1022	COUNTER PLATE (CONTROPIASTRA)	1
147	2526.231	BRACKET (STAFFA)	1
148	96D1009	LEVER (LEVA)	1
149	90D1030	SPACER (DISTANZIALE)	3
150	201095	SCREW (VITE M14X130)	3
151	201094	SCREW (VITE M14X50)	1
152	201093	SCREW (VITE M14X25)	3
153	202113	NUT (DADO M12X 1,5)	4
154	203210	COLLAR (ROSETTA DIAM. 14 SPEZZATA)	7
155	201197	SCREW (VITE TE M12 X 50)	2
156	202006	NUT (DADO)	2
160	96D1008	SHAFT (ALBERO CON IDROGUIDA)	1

IDROGUIDA

BREMACH

BREMACH



1

4



3 5



1

AVVISATORE ACUSTICO

BREMACH

Pos	Codice	Descrizione	Q.tà
1	9619101	WARNING HORN (AVVISATORE ACUSTICO)	1
2	2814.002	BRACKET (STAFFA SUPER AVV. ACUSTICO)	1
3	201021	SCREW (VITE M8X35)	2
4	16750221	NUT (DADO EF M8)	1
5	203003	COLLAR (ROSETTA CON. EL. 8X16X1,9)	2

AVVISATORE ACUSTICO

BREMACH

BREMACH



CONDIZIONATORE COMANDI ELETTRICI

BREMACH

Pos	Codice	Descrizione	Q.tà
1	96H2011	BRACKET (STAFFA PER RADIATORE)	2
2	96H2012	BRACKET (STAFFA BLOCCAGGIO TUBO F1C)	2
3	61335	TUBE (TUBO SPIRALE TRASPARENTE)	1,5
4	96P0215	CODENSER (CONDENSATORE)	1

CONDIZIONATORE COMANDI ELETTRICI

BREMACH

BREMACH

5



6



CONDIZIONATORE COMANDI ELETTRICI

BREMACH

Pos	Codice	Descrizione	Q.tà
5	96P2018	KIT (KIT TUBAZIONI CLIMA F1A/F1C 176CV)	1
6	96P2019	KIT (KIT TUBAZIONI CLIMA F1A/F1C 146CV)	1

CONDIZIONATORE COMANDI ELETTRICI

BREMACH

BREMACH

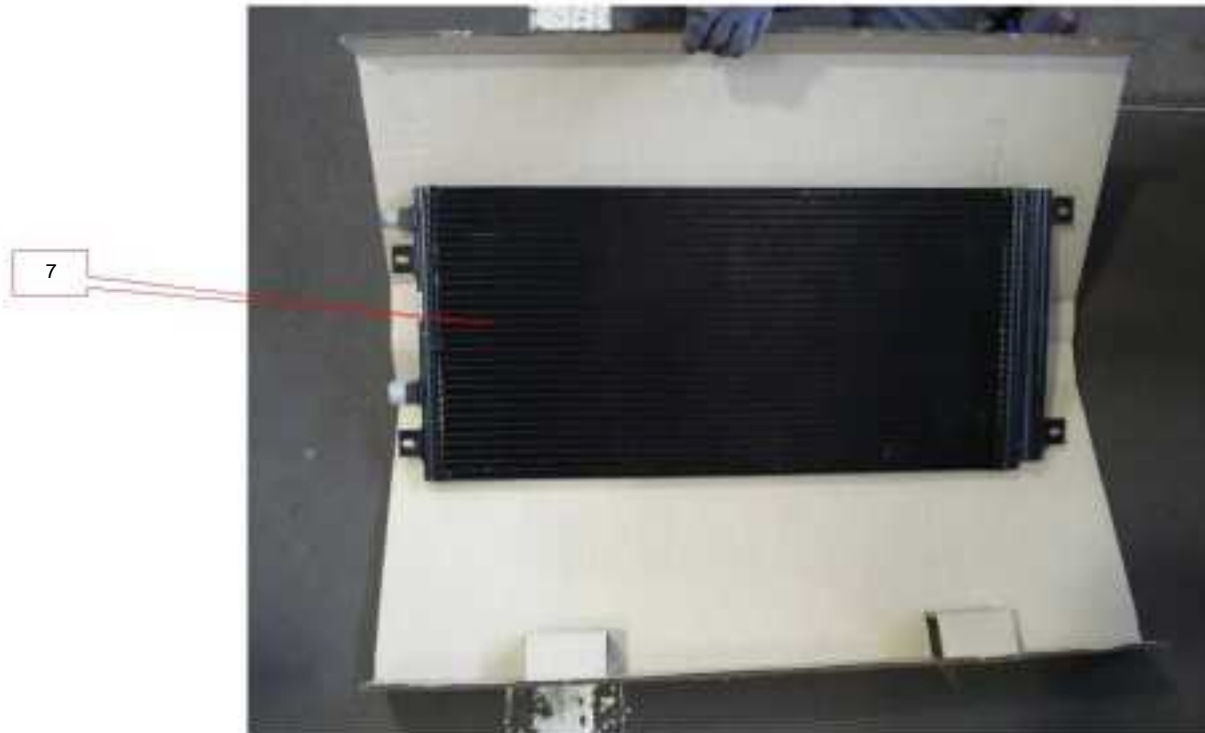

CONDIZIONATORE COMANDI ELETTRICI

Pos	Codice	Descrizione	Q.tà
7	96P2015	CODENSER (CONDENSATORE CLIMA F1A/F1C)	1

BREMACH

BREMACH

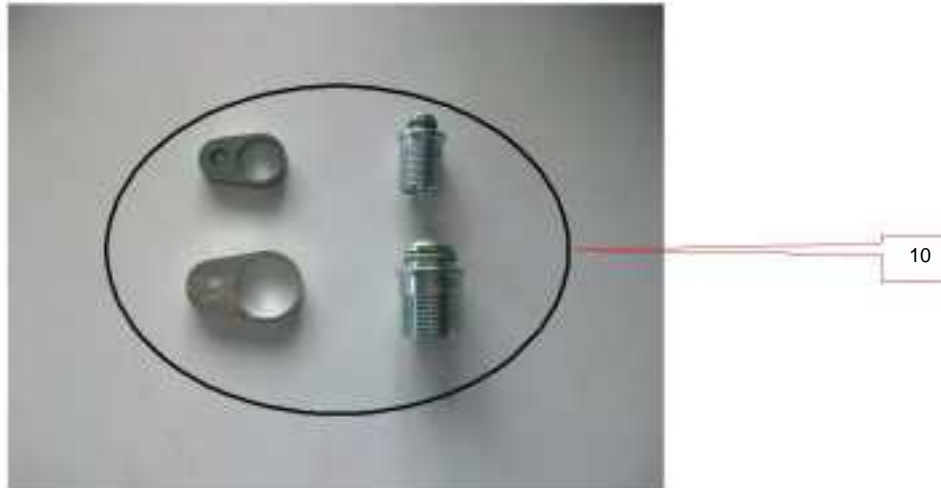

CONDIZIONATORE COMANDI ELETTRICI

BREMACH

Pos	Codice	Descrizione	Q.tà
8	96P2009	PRESSURE DEVICE (PRESSOSTATO TRINARY)	1
9	96P2016	KIT (KIT RACCORDI F1A/F1C 176CV)	1
10	96P2017	KIT (KIT RACCORDI F1C 146CV)	1

CONDIZIONATORE COMANDI ELETTRICI

BREMACH

BREMACH



CABINA

BREMACH

Pos	Codice	Descrizione	Q.tà
5	96D1007	STEERING WHEEL (VOLANTE COMPL. M.Y. 08)	1
10	96P1606	BLOCK (BLOCCHETTO ACC. + CHIAVI E BLOCCHETTI)	1
15	202204	NUT (DADO M18X1,5 H 15 DX)	1

CABINA

BREMACH

BREMACH



90



10

5



20

30

20

85



15

90



175



176

177

178

CABINA

BREMACH

Pos	Codice	Descrizione	Q.tà
5	96P6007D	GRID (GRIGLIA MOSTRINA SFIATO CABINA POSTERIORE DX)	1
10	96P6007S	GRID (GRIGLIA MOSTRINA SFIATO CABINA POSTERIORE SX)	1
15	E4085	RUBBER (GOMMINO CAVATAPPI 4872)	3
20	B9121	PLATE (PIASTRA PER ATTACCO LAMANEVE)	2
30	96N1000	BUMPER (PARAURTI ANTERIORE)	1
85	96E1030	GRID (GRIGLIA RADIATORE)	1
90	16585724	SCREW (VITE M6X16 FLANG.)	4
175	91F1017	SENSOR (SENSORE DI ACCELERAZIONE)	1
176	17816314	SPACER (DISTANZIALE)	2
177	204011	SCREW (VITE AUTOF. 4,8X45)	2
178	203300	COLLAR (ROSETTA PLASTICA)	2

CABINA

BREMACH

BREMACH

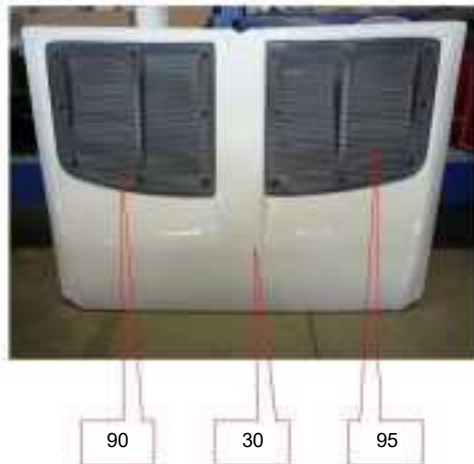
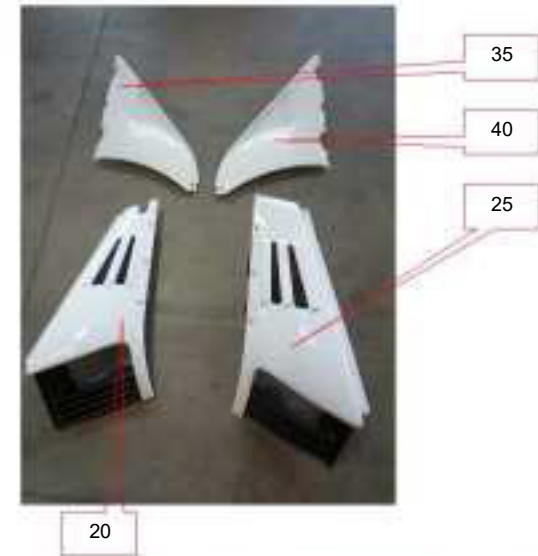

CABINA

Pos	Codice	Descrizione	Q.tà
5	SV60000000	CRANE (LAMIERA SCOCCA VERNICIATA)	1
7	96E1000D	DOOR (PORTIERA ANTER. DX VERNICIATA)	1
8	96E1000S	DOOR (PORTIERA ANTER. SX VERNICIATA)	1
10	96E1066D	WHEEL CASE (PASSARUOTA ANTER. DX)	1
15	96E1066S	WHEEL CASE (PASSARUOTA ANTER. SX)	1
20	96E1001D.GR	FLANK (FIANCATA DX COL. IN MASSA)	1
25	96E1001S.GR	FLANK (FIANCATA SX COL. IN MASSA)	1
30	96E1002.GR	HOOD (COFANO MOBILE G.SX COL. IN MASSA)	1
35	96E1004D.GR	FLANK (FIANCATA LAT. DX COL. IN MASSA)	1
40	96E1004S.GR	FLANK (FIANCATA LAT. SX COL IN MASSA)	1
55	96P7002S	FOOTBOARD (PEDANA DI SALITA COMPL. SX)	1
60	96P7002D	FOOTBOARD (PEDANA DI SALITA COMPL. DX)	1
61	96E1029D	TUBE (TUBO RINFORZO PEDANA DX)	1
62	96E1029S	TUBE (TUBO RINFORZO PEDANA SX)	1
65	96P7001	CROSS MEMBER (TRAVERSA PORTA PLANCIA COMPLETA)	1
90	96E1021D	GRID (GRIGLIA COFANO MOTORE DX)	1
95	96E1021S	GRID (GRIGLIA COFANO MOTORE SX)	1

BREMACH

BREMACH



65



75



80

135



125



130



140

CABINA

BREMACH

Pos	Codice	Descrizione	Q.tà
65	96P7001	CROSS MEMBER (TRAVERSA PORTA PLANCIA COMPLETA)	1
75	96P2003	DOOR (PORTIERA ISPEZIONE PORTELLO)	1
80	96P7000	TIE-ROD (TIRANTE FERRO PORTA)	2
125	96E1032D	BRACKET (STAFFA DX PER MOTORINO ASSIEME FARI)	1
130	96E1032S	BRACKET (STAFFA SX PER MOTORINO ASSIEME FARI)	1
135	96E1033D	STIFFENER (RINFORZO EST. TIRANTE ARR. PORTA (DX))	1
140	96E1033S	STIFFENER (RINFORZO EST. TIRANTE ARR. PORTA (SX))	1

CABINA

BREMACH

BREMACH

72



1



CABINA

BREMACH

Pos	Codice	Descrizione	Q.tà
1	96E1003.GR	ROOF (PADIGLIONE COLORATO IN MASSA)	1
72	96E1006	CAP (TAPPO DI CHIUSURA PARETE CRUSCOTTO)	1

CABINA

BREMACH

BREMACH

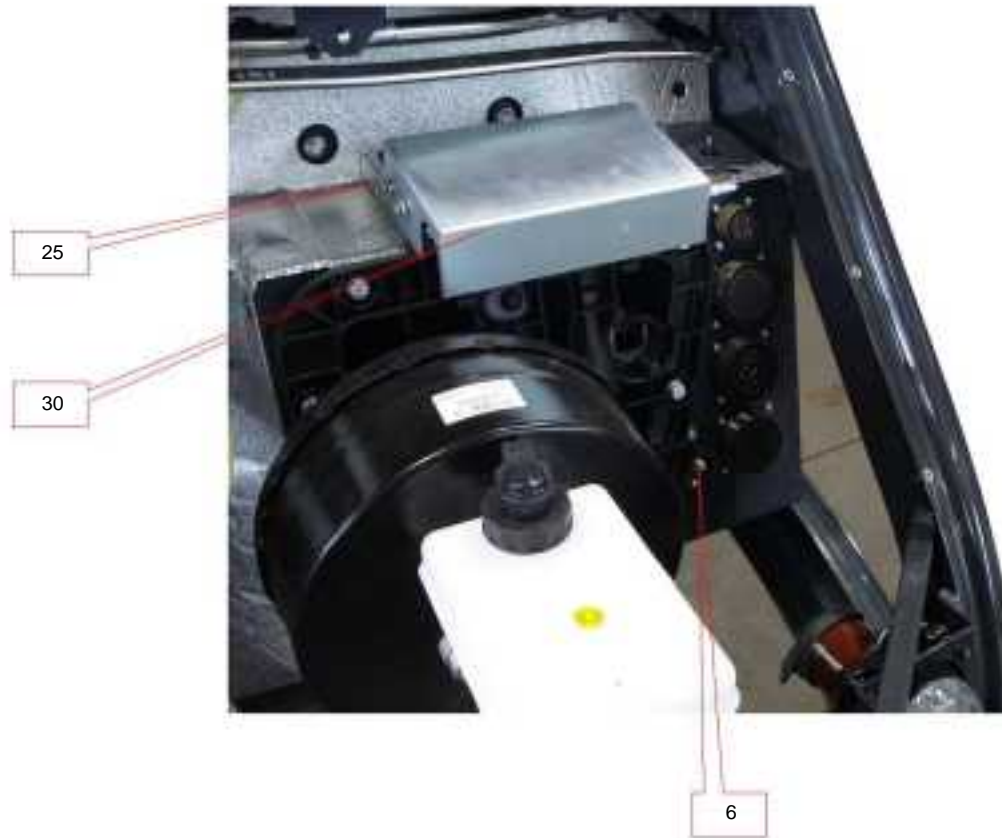

CABINA

BREMACH

Pos	Codice	Descrizione	Q.tà
6	9611047	PIPE SOCKET (RACCORDO PASSAPARETE POS. DI POTENZA)	1
25	96N2004	SUPPORT (SUPPORTO CENTRALINA MOTORE)	1
30	96N2005	PROTECTION (PROTEZIONE PER CENTRALINA)	1

CABINA

BREMACH

BREMACH



55 45 40



50
45

45 35

30

5



CABINA

BREMACH

Pos	Codice	Descrizione	Q.tà
5	96S3001	DOWEL (TASSELLO ELASTICO SOSPENS. CABINA)	4
30	201160	SCREW (VITE TCEI M12X100)	4
35	201041	SCREW (VITE M10X25)	8
40	202104	NUT (DADO AUTOBLOCCANTE M12)	4
45	203004	WASHER (RONDELLA D.10)	12
50	201043	SCREW (VITE M10X35)	4
55	203005	COLLAR (ROSETTA D. 12)	4

CABINA

BREMACH

BREMACH



10 5

35

15 15

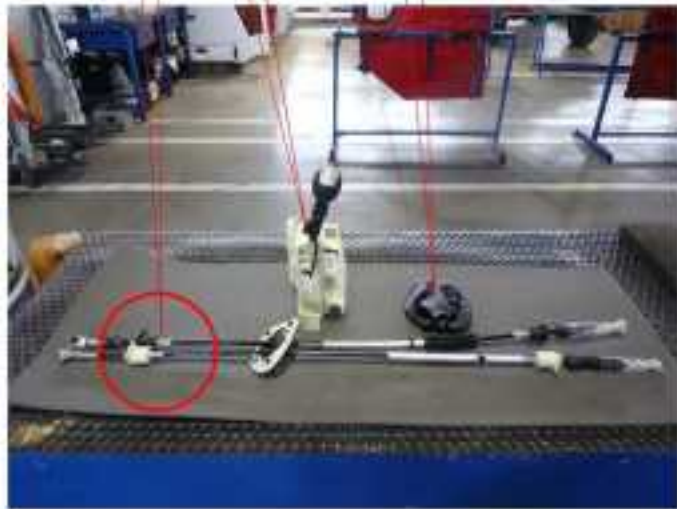

CABINA

BREMACH

Pos	Codice	Descrizione	Q.tà
5	96L8001	SUPPORT (SUPPORTO COMANDO CAMBIO)	1
10	96L8002	CONTROL (COMANDO FLESSIBILE)	1
15	96L8003	TIE-ROD (TIRANTE PER COMANDO)	2
35	96L8004	PROTECTION (PROTEZIONE CUFFIA COMANDO CAMBIO)	1

CABINA

BREMACH

BREMACH



25



40

10

20



30

35

35



25



5

CABINA

BREMACH

Pos	Codice	Descrizione	Q.tà
5	96L9501	PEDALS (PEDALIERA COMPLETA M.Y. 08)	1
10	201023	SCREW (VITE M8X30 UNI 5739-65 ZINCOTR)	8
20	203003	COLLAR (ROSETTA CON. EL. 8X16X1,9)	16
25	96L5000	PEDAL (PEDALE ACCELERATORE)	1
30	95L5003	SWITCH (INTERRUTTORE FRIZIONE)	1
35	95I1012	SWITCH (INTERRUTTORE FRENO)	2
40	96L9503	SPRING (MOLLA)	2

CABINA

BREMACH

BREMACH



15

10

20

5

25



CABINA

BREMACH

Pos	Codice	Descrizione	Q.tà
5	96P1000	CRYSTAL (CRISTALLO POSTERIORE)	1
10	96P1006	WINDSCREEN (PARABREZZA ANTERIORE)	1
15	96P1012	SEAL (GUARNIZIONE PORTA ANTERIORE)	2
20	61718	SEAL (GUARNIZIONE PER PARABREZZA)	3
25	61721	SEAL (GUARNIZIONE INFER. PER PARABREZZA)	1,5

CABINA

BREMACH

BREMACH

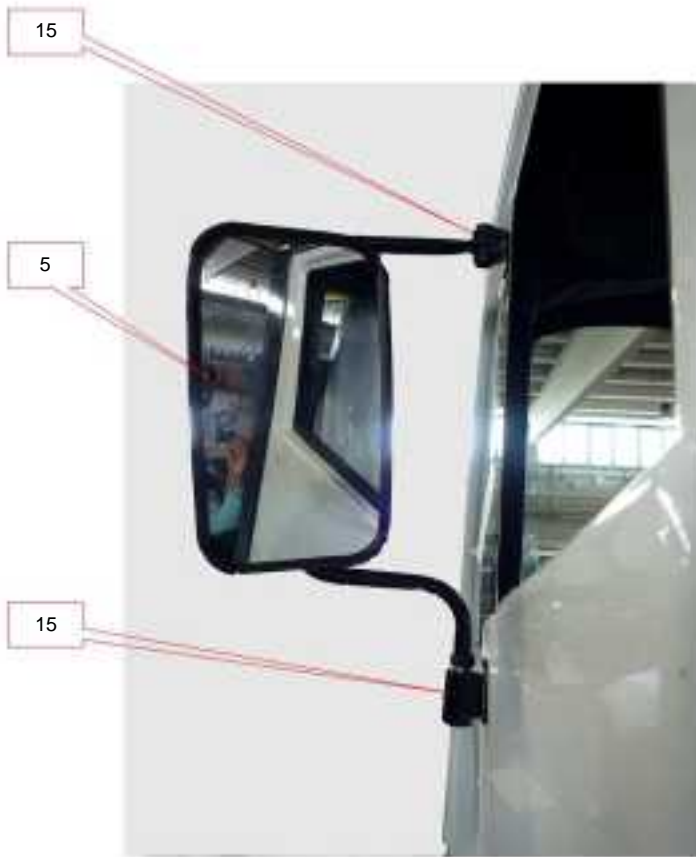

CABINA

BREMACH

Pos	Codice	Descrizione	Q.tà
5	96P1000D	MIRROR (SPECCHIO RETROV. EST. DX)	1
5	96P1020D	MIRROR (SPECCHIO RETROV. EST. DX CARR. LARGA)	1
10	96P1000S	MIRROR (SPECCHIO RETROV. EST. SX)	1
10	96P1020S	MIRROR (SPECCHIO RETROV. EST. SX CARR. LARGA)	1
15	201305	SCREW (VITE 6X20 TSBTC INOX)	12

CABINA

BREMACH

BREMACH



10 30 15



5 20 20 36



21 21



11



CABINA

BREMACH

Pos	Codice	Descrizione	Q.tà
5	96E1002.GR	HOOD (COFANO MOBILE G.SX COL. IN MASSA)	1
10	96P1025	SEAL (GUARNIZIONE COFANO)	1
11	96E1001D.GR	FLANK (FIANCATA DX COL. IN MASSA)	1
15	96P1026	SEAL (GUARNIZIONE PER CONVOGL.)	1
20	96P1014	LOCK (SERRATURA COFANO SUPER. (SENZA CHIAVE))	1
21	96P1016	LOCK (SERRATURA COFANO INFER. (SENZA CHIAVE))	1
25	96P1015	KEY (CHIAVE PER SERR. COFANO)	1
30	96P1022	PIVOT (PERNO POSTERIORE FISSAGGIO COFANO)	2
36	91P7017	SPACER (DISTANZIALE M6)	2

CABINA

BREMACH

BREMACH



5



101

190

195

135

95

100

10



35

40

30

35

170

175

215



180

195

180

VANO SOTTO PIASTRA

166

170

CABINA

BREMACH

Pos	Codice	Descrizione	Q.tà
5	96E1004	INSTRUMENT PANEL (PLANCIA PORTASTRUMENTI)	1
10	96P1607	GRID (GRIGLIA DIFFUSORE ARIA SU PLANCIA)	4
30	96P1601	COVER (MOSTRINA)	1
35	96P1602	KNOB (POMELLO)	2
40	96P1603	KNOB (POMELLO)	1
95	96E1037	COVERING (RIVESTIMENTO SUPERIORE MOBILETTO SERIGRAFATO)	1
100	96E1015D	COVERING (RIVESTIMENTO FRONTALE DX)	1
101	96E1015S	COVERING (RIVESTIMENTO FRONTALE SX)	1
135	96P1611	MODULE (MODULO 16 LED)	1
166	96I1046	GEARCASE (CENTRALINA PER COMM. ROTATIVI)	1
170	96I1027	SWITCH (INTERRUTTORE COMMUTATORE PER RIDOTTE)	1
175	96I1028	SWITCH (INTERRUTTORE COMMUTATORE PER SERV. AUSIL.)	1
180	96I1062	SWITCH (INTERRUTTORE SU PLANCIA)	1
190	96I1031	SWITCH (INTERRUTTORE 1/2 MARCIA)	1
195	83984	POP (POP NERO)	3
215	96I1060	SWITCH (INTERRUTTORE EMERGENZA)	1

CABINA

BREMACH

BREMACH



80

50

130

55



200

285

290

90



295



125

85

201

CABINA

Pos	Codice	Descrizione	Q.tà
50	96I1045	INSTRUMENTS (STRUMENTAZIONE ODOMETRO MASTER)	1
55	96I1026	INSTRUMENTS (STRUMENTAZIONE RPM GASOLIO ACQUA)	1
80	96E1011	PANEL (PANNELLO PER FISSAGGIO STRUMENTI)	1
85	96GE1013D	COVERING (RIVESTIMENTO INFER. DX SOTTO STRUM.)	1
90	96GE1013S	COVERING (RIVESTIMENTO INFER. SX SOTTO STRUM.)	1
125	90I1103	FRAME (CORNICE COMPONENTIBILE)	2
130	96P1610	MODULE (MODULO 8 LED)	4
200	96P1612	LABEL (ETICHETTA REGOL. ASSETTO FARI)	1
201	90P1617	CAP (TAPPO PER PULSANTE)	2
285	96I1029	SWITCH (INTERRUTTORE POTENZ. REGOLAZIONE FARI)	1
290	96I1064	KNOB (POMELLO COMANDO POTENZ.)	2
295	96I1034	BRACKET (STAFFA FISSAGGIO CONNETTORI DIAGNOSTICA)	1

BREMACH

BREMACH



275

280

220

225



151

152

CABINA

BREMACH

Pos	Codice	Descrizione	Q.tà
151	91P1014	TACHOGRAPH (TACHIGRAFO DIGITALE)	1
152	91P1016	BRACKET (STAFFA DI FISSAGGIO)	1
220	90I1146	SWITCH (INTERRUTTORE BASE PER CASSONE RIBALT.)	1
225	95I1002	BUTTON (PULSANTE BASCULA CASSONE)	1
275	90I1152	SWITCH (INTERRUTTORE BASE DISAB. ABS 60 Q.LI)	1
280	90I1151	SWITCH (INTERRUTTORE BASCULA PER TASTO ABS 60 Q.LI)	1

CABINA

BREMACH

BREMACH



105



260

255

270

265

255

260



135

65

70

60

130

50

60

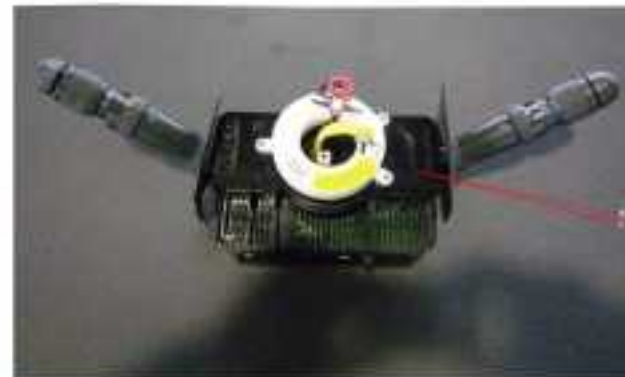

45

CABINA

Pos	Codice	Descrizione	Q.tà
45	96P1608	SWITCH (INTERRUTTORE DEVIAGUIDA)	1
50	96I1045	INSTRUMENTS (STRUMENTAZIONE ODOMETRO MASTER)	1
60	91I1059	CABLE (CAVO COLL. ODOMETRO/CONTAGIRI)	2
65	96I1048	CABLE (CAVO LIN DA 36 POLLICI)	1
70	91I1048	INSTRUMENTS (STRUMENTAZIONE MODULO TACHIMETRICO)	1
105	96E1016	COVERING (RIVESTIMENTO LATER. SUPER. DX)	1
130	96P1610	MODULE (MODULO 8 LED)	4
135	96P1611	MODULE (MODULO 16 LED)	1
255	90P1612	LIGHTER (ACCENDISIGARI)	2
260	90P1611	RING NUT (GHIERA ACCENDIS.)	2
265	90P1613	SPARK PLUG (CANDELA ACCENDIS.)	1
270	91I1028	SWITCH (INTERRUTTORE CICALINA 12 VOLTS)	1

BREMACH

BREMACH

25



5



10



15

20



26

CABINA

BREMACH

Pos	Codice	Descrizione	Q.tà
5	96E1001DGR	FLANK (FIANCATA ANT. DX COMPLETO DI CONVOGLIATORE)	1
10	96P2001	AIR-CONDITIONER (CLIMATIZZATORE)	1
15	96P2008	FILTER (FILTRO ANTIPOLLINE)	1
20	96P2010	TUBE (TUBO IN GOMMA PER SCARICO CONDENSA)	1
25	90E1008	GUIDE HOOD (CONVOGLIATORE ARIA PIEDI PLANCIA)	1
26	96E1005	SEAL (GUARNIZIONE PASSAGGIO TUBI CLIMAT.)	1

CABINA

BREMACH

BREMACH



5



15



20

CABINA

BREMACH

Pos	Codice	Descrizione	Q.tà
5	96P3001	WINDSCREEN WIPER (TERGICRISTALLO)	1
15	96P3006	ARM (BRACCIO CON SPRUZZATORE)	2
20	96P3007	BRUSHES (SPAZZOLE TERGI LUNGH. 550 mm)	2

CABINA

BREMACH

BREMACH



55



60



30 25 10



35

65



40

CABINA

Pos	Codice	Descrizione	Q.tà
10	96P3002	RING (ANELLO FISSAGGIO TERGICRISTALLO)	2
25	96P3008	WASHER (RONDELLA PER TERGI)	2
30	QT1536	NUT (DADO PER TERGI)	2
35	96P3003	TANK (VASCHETTA LAVAVETRO COMPL. DI POMPA)	1
40	96P3009	BRACKET (STAFFA FISSAGGIO VASCH. LAVAVETRO)	1
55	96P3004	PIPE SOCKET (RACCORDO PASSAPARETE PER LAVAVETRO)	2
60	96P3005	"VALVE (VALVOLA ANTIRITORNO A ""T"")	1
65	61083	TUBE (TUBO LAVAVETRO D= 4 X 6)	1

BREMACH

BREMACH



CABINA

BREMACH

Pos	Codice	Descrizione	Q.tà
5	96P4001	MAT (TAPPETO CABINA SINGOLA)	1
10	91E1013	CAP (TAPPO)	4

CABINA

BREMACH

BREMACH



CABINA

BREMACH

Pos	Codice	Descrizione	Q.tà
5	96P5001	SEAT (SEDILE ANTERIORE MOLLEGG. SENZA APPOGG. (WEBASTO))	3
5	96P5004	SEAT (SEDILE ANTERIORE MOLLEGG. SENZA APPOGG. (ISRI))	3
10	96P5002	HEADREST (APPOGGIATESTA WEBASTO)	2
10	96P5005	HEADREST (APPOGGIATESTA ISRI)	3

CABINA

BREMACH

BREMACH



30 5

30 10



10

5

60

70

50

15



60

65

CABINA

BREMACH

Pos	Codice	Descrizione	Q.tà
5	9611000	HEADLAMP (FARO H7 90mm ANABB.)	2
10	9611001	HEADLAMP (FARO PROF. FF - H7 ABBAGL.+ POS.)	2
15	9611003	CALIBRATOR (CORRETTORE ASSIEME PER 008193)	2
30	9611008	COVER (COPERCHIO POSTERIORE)	4
50	9611006	INDICATOR (INDICATORE DIREZ. ANTER.)	2
60	9111070	INDICATOR (INDICATORE DIREZ. LATER. CL. 6)	2
65	202003	NUT (DADO M6)	2
70	83011	LAMP (LAMPADA 12/21 PER IND. DIREZ.)	2

CABINA

BREMACH

BREMACH

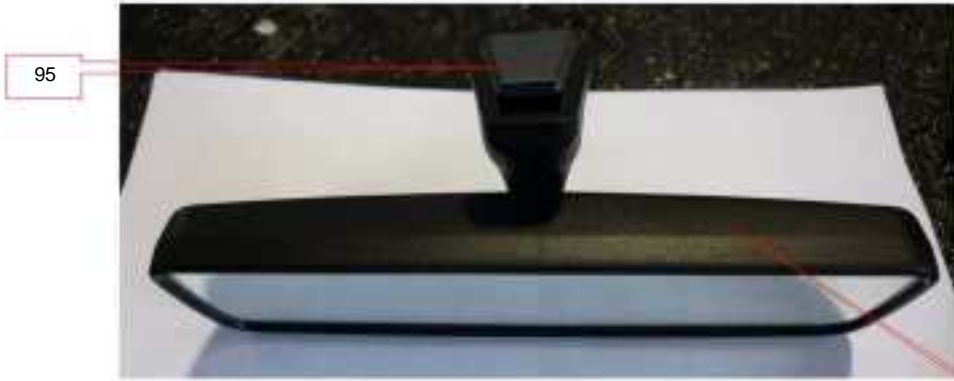

95



95



90

85

CABINA

BREMACH

Pos	Codice	Descrizione	Q.tà
85	96P6013	OVERHEAD LIGHT (PLAFONIERA CENTRALE M.Y. 08)	1
90	96P6021	MIRROR (SPECCHIO RETROVISORE INTERNO)	1
95	96P6022	PLAQUE (PIASTRINA INCOLLATA)	1

CABINA

BREMACH

BREMACH



Posizione vano motore



15



5

17

10

CABINA

BREMACH

Pos	Codice	Descrizione	Q.tà
5	96P6019	KIT (KIT ISOLAMENTO LEGETOLEX)	1
10	96P6020	KIT (KIT ISOLAMENTO VANO MOTORE)	1
15	61724	STRIP (STRISCIA ALLUM. PER ISOL. VANO MOTORE)	1
17	201302	SCREW (VITE M5X16 INOX)	1
17	203002	WASHER (RONDELLA D.6)	1
17	90P4081	COMPASS (BUSSOLA M5)	1

CABINA

BREMACH

BREMACH



10 5



12

11



95

20 25



100



116



115

110

110

CABINA

BREMACH

Pos	Codice	Descrizione	Q.tà
5	96P6008D	RIB (ALETTA PARASOLE DX)	1
10	96P6008S	RIB (ALETTA PARASOLE SX)	1
11	96P6012	SUPPORT (SUPPORTO CENTR. PER ALETTA PARASOLE)	2
12	201306	SCREW (VITE TSBTC 6X16 BRUNITE)	2
20	96P6011	HANDLE (MANIGLIA INT. DI SALITA)	2
25	90P4018	COMPASS (BUSSOLA M 8 FISSAGGIO MANIGLIA)	4
95	92P1603	CASE (CONTENITORE VANO AUTORADIO)	2
100	96P6023D	HANDLE (MANIGLIA MANCORRENTE DX DI SALITA)	1
100	96P6023S	HANDLE (MANIGLIA MANCORRENTE SX DI SALITA)	1
110	90P1012	PLAQUE (PIASTRINA DI CHIUSURA)	2
115	204016	SCREW (VITE AUTOF. TC 3,9X16 T. TONDA APERTA)	8
116	201301	SCREW (VITE TSBTC M6X16 INOX)	4

CABINA

BREMACH

BREMACH



CABINA

BREMACH

Pos	Codice	Descrizione	Q.tà
1	96P6003	COVERING (RIVESTIMENTO PARETE POSTER.)	1
2	95P6021	BOTTON (BOTTONE DI FISSAGGIO)	4
7	96D1005	COVERING (RIVESTIMENTO PIANTONE STERZO)	1
70	96D1004	COVERING (RIVESTIMENTO PIANTONE STERZO)	1
80	96D1006	BRACKET (STAFFA FISSAGGIO RIVESTIMENTO PIANTONE)	1
85	17030504	SCREW (VITE TBIC M4X16 FISSAGGIO RIVETTO PIANTONE)	2
120	96I1043	CLAMP (MORSETTO FERMACAVO)	4

CABINA

BREMACH

BREMACH



CABINA

BREMACH

Pos	Codice	Descrizione	Q.tà
5	90P6045	BELT (CINTURA ANTERIORI(COPPIA))	1
10	90P6046	BELT (CINTURA CENTRALE 3°POSTO)	1
50	96P6026	BRACKET (STAFFA ATTACCO FRUSTINO CINTURE)	3

CABINA

BREMACH

BREMACH

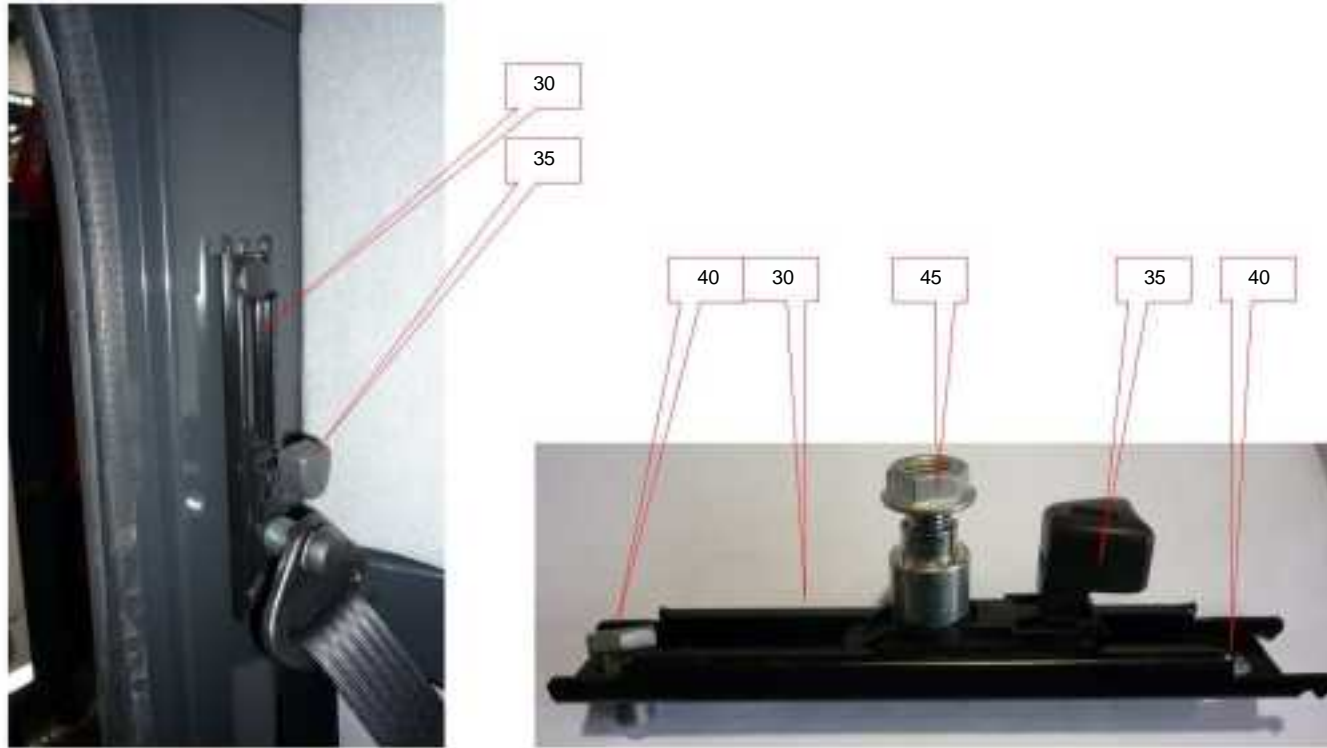

CABINA

BREMACH

Pos	Codice	Descrizione	Q.tà
30	96P6014	RESET (REGOLATORE)	2
35	96P6018	KNOB (POMELLO PER REGOLAT.)	2
40	QT1581	SCREW (VITE 7/16)	4
45	QT1578	NUT (DADO 7/16)	2

CABINA

BREMACH

BREMACH

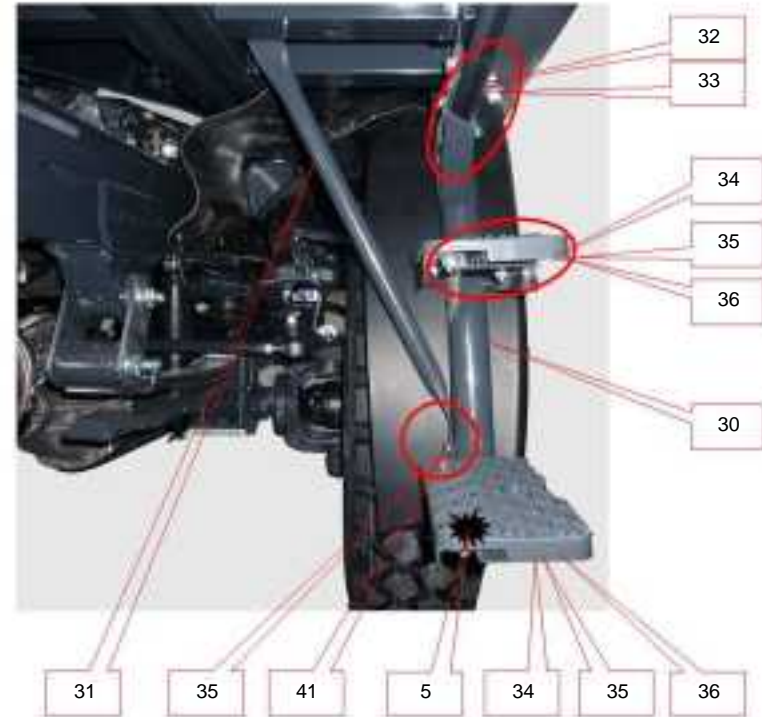

CABINA

BREMACH

Pos	Codice	Descrizione	Q.tà
5	96P7011	STRUCTURE (STRUTTURA PREDELLINO DI SALITA)	4
10	96P7017	EXTENSION (PROLUNGA SU PREDISPOSIZIONE DI SALITA)	2
15	201314	SCREW (VITE TSBTC M6X40 4.8 BRUNITA)	4
25	16750121	NUT (DADO FLANGIATO M6)	4
30	96P7002D	FOOTBOARD (PEDANA DI SALITA COMPL. DX)	1
30	96P7002S	FOOTBOARD (PEDANA DI SALITA COMPL. SX)	1
31	96E1029D	TUBE (TUBO RINFORZO PEDANA DX)	1
31	96E1029S	TUBE (TUBO RINFORZO PEDANA SX)	1
32	201040	SCREW (VITE M10X20)	8
33	203004	WASHER (RONDELLA D.10)	8
34	201023	SCREW (VITE M8X30 UNI 5739-65 ZINCOTR)	4
35	201021	SCREW (VITE M8X35)	12
36	16750221	NUT (DADO EF M8)	12
41	203003	COLLAR (ROSETTA CON. EL. 8X16X1,9)	4

CABINA

BREMACH

BREMACH

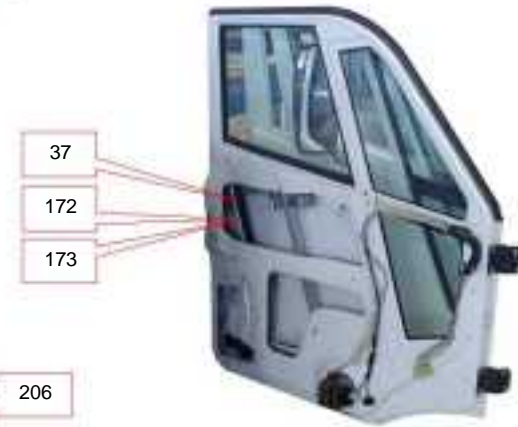

PORTIERE

Codice	Descrizione	Q.tà	
5	96P1001D	CRYSTAL (CRISTALLO SCEND. PORTA ANT. DX)	1
5	96P1001S	CRYSTAL (CRISTALLO SCEND. PORTA ANT. SX)	1
10	96P1002D	CRYSTAL (CRISTALLO SUPER. PORTA (DX))	1
10	96P1002S	CRYSTAL (CRISTALLO SUPER. PORTA (SX))	1
20	96P1003D	CRYSTAL (CRISTALLO INFER. PORTA (DX))	1
20	96P1003S	CRYSTAL (CRISTALLO INFER. PORTA (SX))	1
37	96P1054D/S	SEAL (GUARNIZIONE VETRO SCENDENTE)	2
60	96P7010D	PANEL (PANNELLO INT. PORTA DX)	1
65	96P7010S	PANEL (PANNELLO INT. PORTA SX)	1
115	96E1017D	HANDLE (MANIGLIA INT. PORTA (DX))	1
125	96P7012	HANDLE (MANIGLIA ESTERNA)	2
171	96E1039D/S	SEAL (GUARNIZIONE PORTA)	1
172	96P1011S	SEAL (GUIDA-VETRO)	1
173	96P1011D	SEAL (GUIDA-VETRO)	1
206	96P7001S	HINGE (CERNIERA PORTA SX)	2
207	96P7001D	HINGE (CERNIERA PORTA DX)	2

BREMACH

BREMACH

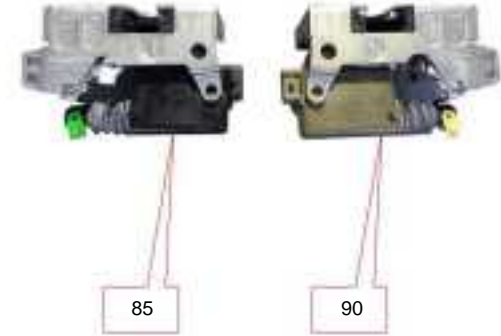
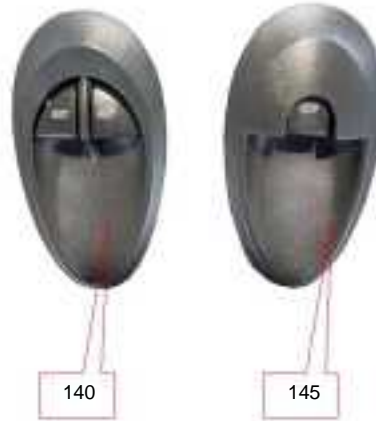
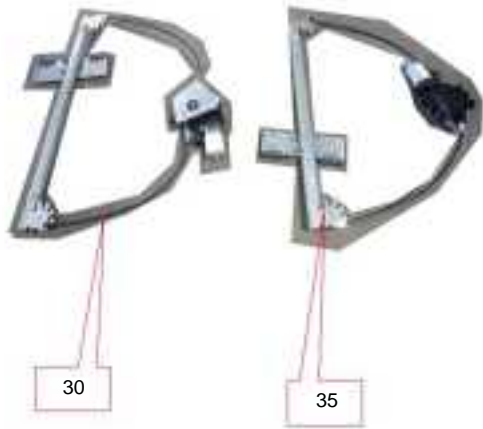

PORTIERE

Pos	Codice	Descrizione	Q.tà
30	96P1008D	ENGINE (MOTORE ALZACRISTALLO DX)	1
35	96P1008S	ENGINE (MOTORE ALZACRISTALLO SX)	1
78	96P7020	HANDLE (MANIGLIA INTERNA SX)	1
80	96P7005	HANDLE (MANIGLIA INTERNA DX)	1
85	96P7006D	LOCK (SERRATURA PORTA DX)	1
90	96P7006S	LOCK (SERRATURA PORTA SX)	1
125	96P7012	HANDLE (MANIGLIA ESTERNA)	2
140	96P7015S	CONTROL (COMANDO VETRI ELETTR. (SX))	1
145	96P7015D	CONTROL (COMANDO VETRI ELETTR. (DX))	1

BREMACH

BREMACH



40



37



172

173



135

136



200



205

47



190



180

PORTIERE

BREMACH

Pos	Codice	Descrizione	Q.tà
37	96P1027	SEAL (GUARNIZIONE VETRO SCENDENTE)	2
40	96P1010	SEAL (GUARNIZIONE LECCAVETRO)	4
47	96P7019	PROTECTION (PROTEZIONE IN GOMMA PER CAVO PORTA)	2
135	96P7029	KIT (KIT TELECOM. SERRAT. PORTA)	1
136	96I1037	BRIDLE (BRIGLIA COLL. SERR. PORTA (MODIF.))	1
172	96P1011S	SEAL (GUIDA-VETRO)	1
173	96P1011D	SEAL (GUIDA-VETRO)	1
180	96I1056	EXTENSION (PROLUNGA APRIPORTA CENTR.)	1
190	96I1007	EXTENSION (PROLUNGA PER MOT. ALZACRISTALLI)	1
200	96I1020D	CABLE (CAVO PER PORTA ANT. DX)	1
205	96I1020S	CABLE (CAVO PER PORTA ANT. SX)	1

PORTIERE

BREMACH

BREMACH

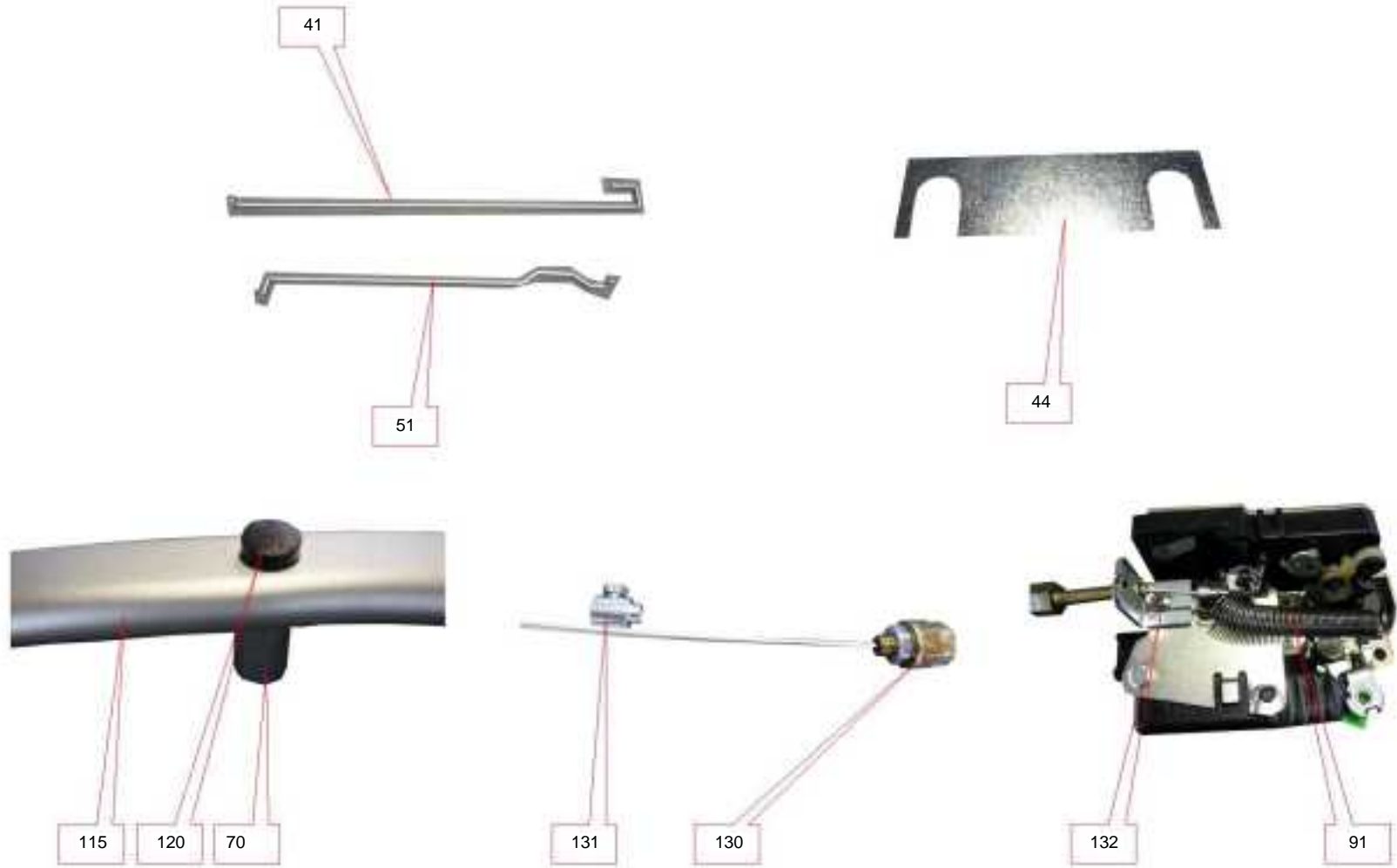

PORTIERE

BREMACH

Pos	Codice	Descrizione	Q.tà
41	96P7021	TIE-ROD (TIRANTE TRA SERRAT. E RINVIO)	2
44	96P7030	THICKNESS (SPESSORE PER REG. CERN. PORTA)	4
51	96P7031	TIE-ROD (TIRANTE TRA SERR. E BLOCCH. CHIAVE)	1
70	91E1014	SPACER (DISTANZIALE PER MANIGL. PORTA)	2
91	81586	SPRING (MOLLA)	2
115	96E1017D	HANDLE (MANIGLIA INT. PORTA (DX))	1
120	96P7028	CAP (TAPPO PER MANCORRENTI PORTA)	6
130	E4090	BOWDEN (BOWDEN COLL. SERRATURA)	2
131	96P7013	CLAMP (MORSETTO FERMACAVO BOWDEN)	2
132	96P1024	STIRRUP (STAFFETTA FISS. BOWDEN)	2

PORTIERE

BREMACH

BREMACH



105

42



68

67



44

77

76



67

68



97

98

95

PORTIERE

BREMACH

Pos	Codice	Descrizione	Q.tà
42	96P1604	DEVICE (DISPOSITIVO CHIUSURA SPORTELLI)	1
44	96P7030	THICKNESS (SPESSORE PER REG. CERN. PORTA)	4
67	96P7022	PIVOT (PERNO PER TIRANTE ARR. PORTA)	2
68	96P7023	SEEGER (SEEGER DIAM 8)	2
76	201041	SCREW (VITE M10X25)	8
77	96P7032	SCREW (VITE M10X25 FISS. SU PORTA)	8
95	96P7009	CHECKING (RISCONTRO SERRATURA)	2
97	96P7026	THICKNESS (SPESSORE PER SCONTR. SERR. SP. 1)	2
98	96P7027	THICKNESS (SPESSORE PER SCONTR. SERR. SP. 2)	2
105	96P7008	FORK (FORCELLA PER PORTA)	1

PORTIERE

BREMACH

BREMACH



- 10
- 20
- 60
- 55
- 90
- 65



5

15

55

55

96



BARRA ANTERIORE

BREMACH

Pos	Codice	Descrizione	Q.tà
5	96N1021D	ARM (BRACCIO SOST.BARRA DX (ANTERIORE))	1
10	96N1021S	ARM (BRACCIO SOST.BARRA SX (ANTERIORE))	1
15	96N1001D	ARM (BRACCIO SOST.BARRA DX (POSTERIORE))	1
20	96N1001S	ARM (BRACCIO SOST.BARRA SX (POSTERIORE))	1
55	61297	PROFILE (PROFILO ALLUMINIO PARACICLISTI)	1
60	91N1018	COVER (COPERCHIO CHIUSURA SUP. ANT.)	1
65	91N1017	COVER (COPERCHIO CHIUSURA ANT.)	1
90	91N1012	PLAQUE (PIASTRINA FISSAGGIO BARRA)	4
95	91N1016	COVER (COPERCHIO DI CHIUSURA)	4
96	91N1064	PLAQUE (PIASTRINA DI FISSAGGIO)	1

BARRA ANTERIORE

BREMACH

BREMACH

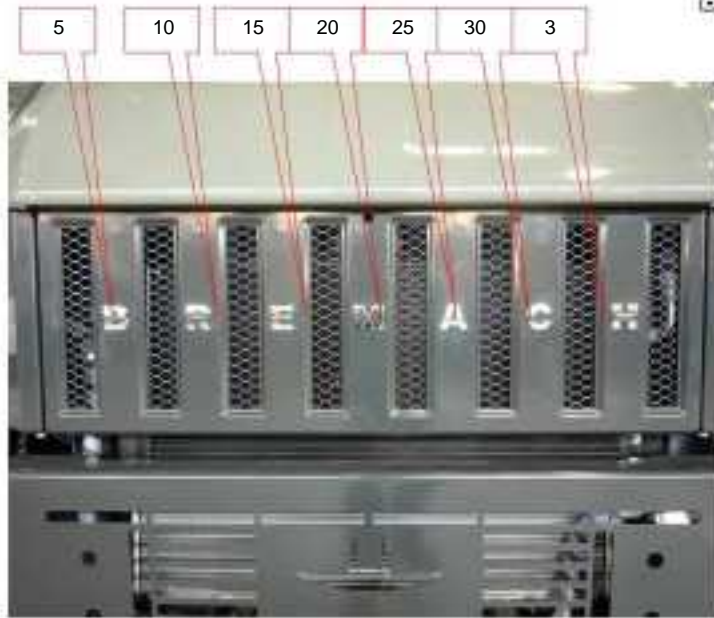

SIGLE E TARGHE

BREMACH

Pos	Codice	Descrizione	Q.tà
3	96T1010	"LETTER (LETTERA ""H"") "	1
5	96T1004	"LETTER (LETTERA ""B"") "	1
10	96T1005	"LETTER (LETTERA ""R"") "	1
15	96T1006	"LETTER (LETTERA ""E"") "	1
20	96T1007	"LETTER (LETTERA ""M"") "	1
25	96T1008	"LETTER (LETTERA ""A"") "	1
30	96T1009	"LETTER (LETTERA ""C"") "	1
40	96T1011	PLATE (TARGHETTA IDENTIF. VEICOLO)	1
50	96T1016	LABEL (ETICHETTA ADESIVA INCLIN. FARO 2%)	1
60	96T1012	PLATE (TARGHETTA CORR. DI FRENATA 83545 N.2))	1

SIGLE E TARGHE

BREMACH

BREMACH

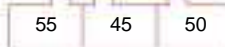
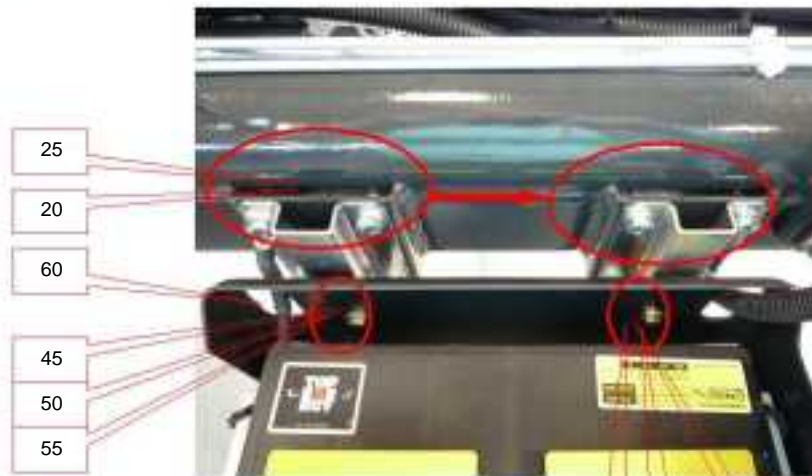

INSTALLAZIONE BATTERIA

Pos	Codice	Descrizione	Q.tà
5	A1013	SUPPORT (SUPPORTO BATTERIA COMPL.)	1
10	90N9403	WHOLE (ASSIEME SEMISCATOLA RIP. BATTERIA)	1
12	90N9404	WHOLE (ASSIEME COPERCHIO RIPARO BATTERIA)	1
15	81400	BATTERY (BATTERIA -110 AH)	1
20	203003	COLLAR (ROSETTA CON. EL. 8X16X1,9)	8
25	201020	SCREW (VITE M8X16)	8
30	A1014	PLAQUE (PIASTRINA FISSAGGIO BATTERIA)	1
35	203002	WASHER (RONDELLA D.6)	1
40	202300	NUT (DADO M6)	1
45	201011	SCREW (VITE TE M6X16)	2
50	203002	WASHER (RONDELLA D.6)	2
55	16750121	NUT (DADO FLANGIATO M6)	2
60	9611050	PLAIT (TRECCIA MASSA MOTORE/CABINA)	1

INSTALLAZIONE BATTERIA

BREMACH

BREMACH

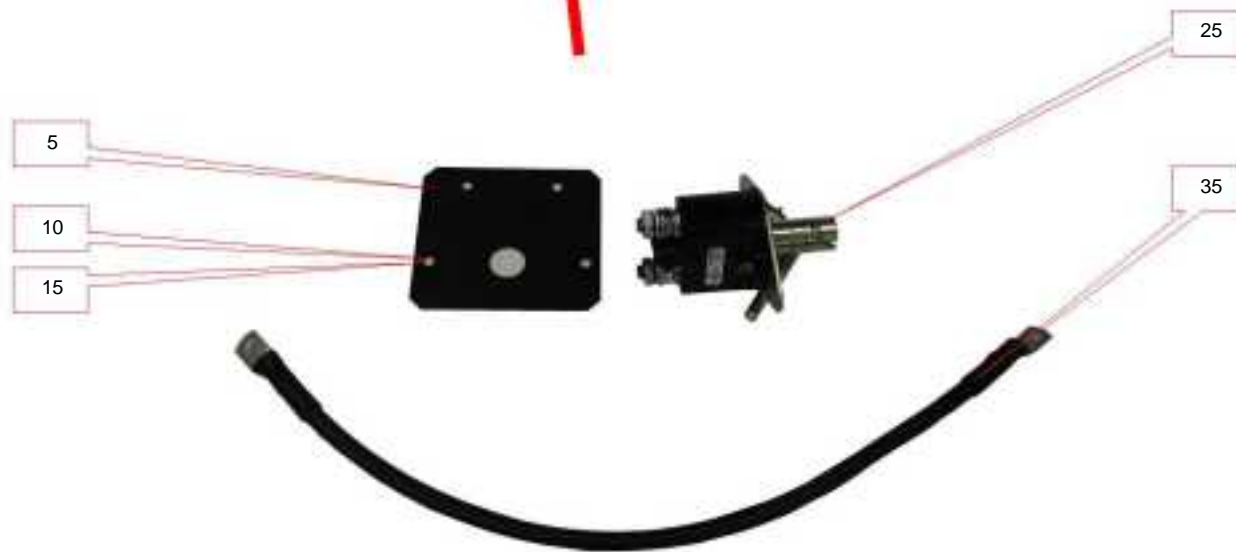

STACCA BATTERIA

BREMACH

Pos	Codice	Descrizione	Q.tà
5	91T3008	SUPPORT (SUPPORTO STACCA BATTERIA)	1
10	16585724	SCREW (VITE M6X16 FLANG.)	4
15	16750621	NUT (DADO EF AUTOBL. M16)	4
25	9111044	SWITCH (INTERRUTTORE STACCA BATTERIA CON CHIAVE)	1
35	9611050	PLAIT (TRECCIA MASSA MOTORE/CABINA)	1

STACCA BATTERIA

BREMACH

BREMACH



5



10

15



25



40

35

STACCA BATTERIA PER CASSONE RIBALTABILE

Pos	Codice	Descrizione	Q.tà
5	90T3009	SUPPORT (SUPPORTO STACCA BATTERIA)	1
10	16585724	SCREW (VITE M6X16 FLANG.)	4
15	16750621	NUT (DADO EF AUTOBL. M16)	4
25	90I1033	INTERRUTTORE STACCA BATTERIA CON CHIAVE	1
35	92I1015	PLAIT (TRECCIA MASSA MOTORE/CABINA)	1
40	96I1054	CABLE (CAVO STACCA BATTERIA/POMPA OLIO)	1

STACCA BATTERIA PER CASSONE RIBALTABILE

BREMACH

BREMACH



GANCIO

	Codice	Descrizione	Q.tà
1	91S3005	TOWING HOOK (GANCIO UNCINO TIPO 250/45)	1
2	91S3006	TOWING HOOK (GANCIO UNCINO SFERA VERSIONE 60 Q.LI TIPO 70C/2)	1
3	91S3004	TOWING HOOK (GANCIO A SFERA)	1
4	91I1005	EQUIPMENT (CABLAGGIO PRESA EPT)	1
5	211014	SCREW (VITE M10X30)	4
6	202117	NUT (DADO AUTOB. M10)	4
7	201042	SCREW (VITE M10X30)	3
8	202103	NUT (DADO AUTOBLOCC M10)	3
9	203004	WASHER (RONDELLA D.10)	3

GANCIO

BREMACH

BREMACH



CASSETTA PORTA ATTREZZI

Pos	Codice	Descrizione	Q.tà
5	96T6005	BOX (CASSETTA PORTA ATTREZZI L. = 500)	1
10	90N2011	BRACKET (STAFFA SUP. SERBATOIO GASOLIO)	2
15	201020	SCREW (VITE M8X16)	8
20	203003	COLLAR (ROSETTA CON. EL. 8X16X1,9)	8
25	201026	SCREW (VITE M8X40)	2
30	16750221	NUT (DADO EF M8)	4
35	203003	COLLAR (ROSETTA CON. EL. 8X16X1,9)	4

CASSETTA PORTA ATTREZZI

BREMACH

BREMACH



5

10



15



FENDINEBBIA

BREMACH

Pos	Codice	Descrizione	Q.tà
5	9011135	HEADLAMP (FARO FENDINEBBIA DA INCASSO)	2
10	9011136	BULB (LAMPADINA 12 V 55 W H1 ALOGENA)	2
15	9611062	SWITCH (INTERRUTTORE SU PLANCIA)	1

FENDINEBBIA

BREMACH

BREMACH



35 105 100



10 86 85 100 5



50



35 65 55



30

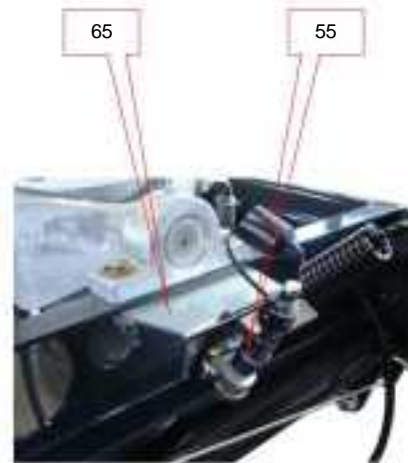

65 55



5 30 5

PREDISPOSIZIONE CASSONE RIBALTABILE

BREMACH

Pos	Codice	Descrizione	Q.tà
5	95M5008	SUPPORT (SUPPORTO SERBATOIO ELETTROPOMPA)	2
10	91M5013	GEARCASE (CENTRALINA PER RIBALTABILE)	1
30	91M4002	TUBE (TUBO OLIO CENTR. - CILINDRO P. 3400)	1
35	91M5003	CYLINDER (CILINDRO ZNT A 5 SFILI COMPL.)	1
50	90M3502	"WARNING HORN (AVVISATORE CICALINO RIBALT. ""CE"") "	1
55	96M3500	SENSOR (FINECORSO A TRAZIONE)	1
65	96M1359	PLATE (PIASTRA FISSAGGIO FINECORSO)	1
85	91M5006	PRESSURE DEVICE (PRESSOSTATO PER CENTR. RIBALT.)	1
86	91M5011	PIPE SOCKET (RACCORDO NIPPLO CIL. 02NR08-04 1/2 1/4)	1
100	96I1051	CABLE (CAVO POMPA EL. CASSIEME RIBALT.)	1
105	91I1011	PLAIT (TRECCIA MASSA TELAIO-CABINA)	1

PREDISPOSIZIONE CASSONE RIBALTABILE